

**Secondary Two Mathematics:  
An Integrated Approach**  
**Module 7**  
**Circles a Geometric  
Perspective**

**By**

**The Mathematics Vision Project:**

Scott Hendrickson, Joleigh Honey,  
Barbara Kuehl, Travis Lemon, Janet Sutorius  
[www.mathematicsvisionproject.org](http://www.mathematicsvisionproject.org)

**In partnership with the  
Utah State Office of Education**

© 2013 Mathematics Vision Project | MVP

In partnership with the Utah State Office of Education

Licensed under the Creative Commons Attribution-NonCommercial-ShareAlike 3.0 Unported license.



## Module 7 – Circles Geometric Perspective

---

**Classroom Task:** 7.1 Centered – A Develop Understanding Task

*Searching for center of rotation using perpendicular bisectors as a tool (G.C.2)*

**Ready, Set, Go Homework:** Circles Geometric Perspective 7.1

**Classroom Task:** 7.2 Circle Dilations– A Solidify Understanding Task

*Proving circles similar (G.C.1)*

**Ready, Set, Go Homework:** Circles Geometric Perspective 7.2

**Classroom Task:** 7.3 Cyclic Polygons – A Solidify Understanding Task

*Examining relationships between central angles, inscribed angles, circumscribed angles and their arcs (G.C.2, G.C.3, G.C.4)*

**Ready, Set, Go Homework:** Circles Geometric Perspective 7.3

**Classroom Task:** 7.4 Planning the Gazebo – A Develop Understanding Task

*Developing formulas for perimeter and area of regular polygons (G.GMD.1)*

**Ready, Set, Go Homework:** Circles Geometric Perspective 7.4

**Classroom Task:** 7.5 From Polygons to Circles – A Solidify Understanding Task

*Justifying formulas for circumference and area of circles using intuitive limit arguments (G.GMD.1)*

**Ready, Set, Go Homework:** Circles Geometric Perspective 7.5

**Classroom Task:** 7.6 Circular Reasoning – A Practice Understanding Task

*Practicing circle relationships (G.C.2)*

**Ready, Set, Go Homework:** Circles Geometric Perspective 7.6

**Classroom Task:** 7.7 Pied – A Develop Understanding Task

*Using proportional reasoning to calculate arc length and area of sectors (G.C.5)*

**Ready, Set, Go Homework:** Circles Geometric Perspective 7.7

**Classroom Task:** 7.8 Madison’s Round Garden – A Practice and Develop Understanding Task

*Using the ratio of arc length to radius to develop radians as a way of measuring angles (G.C.5)*

**Ready, Set, Go Homework:** Circles Geometric Perspective 7.8

**Classroom Task:** 7.9 Rays and Radians – A Solidify and Practice Understanding Task

*Converting between degree measure and radian measure of an angle (G.C.5)*

**Ready, Set, Go Homework:** Circles Geometric Perspective 7.9

**Classroom Task:** 7.10 Sand Castles – A Practice Understanding Task

*Working with volume and scaling to see relationships (G.GMD.1, G.GMD.3)*

**Ready, Set, Go Homework:** Circles Geometric Perspective 7.10



# 7.1 Centered

## *A Develop Understanding Task*

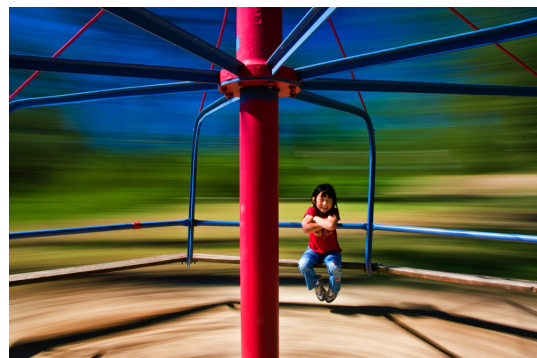

Travis and Tehani know how to construct the image of a rotation when given the center and angle of rotation, but today they have encountered a different issue: how do you find the center of rotation when a rotated image and its pre-image are given? They decide to explore this idea with their friends, Carlos and Clarita.

Each pair of friends creates a “puzzle” for the other pair by sketching a drawing on graph paper in which a rotation of a figure is shown, but the center of rotation is not marked. The other pair has to figure out where the center of rotation is located. Here are the “puzzles” they created for each other.

**Travis and Tehani’s Puzzle**

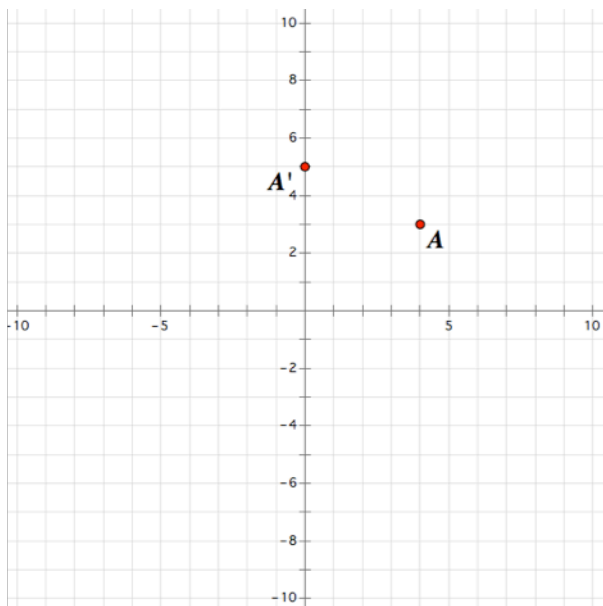

**Carlos and Clarita’s Puzzle**

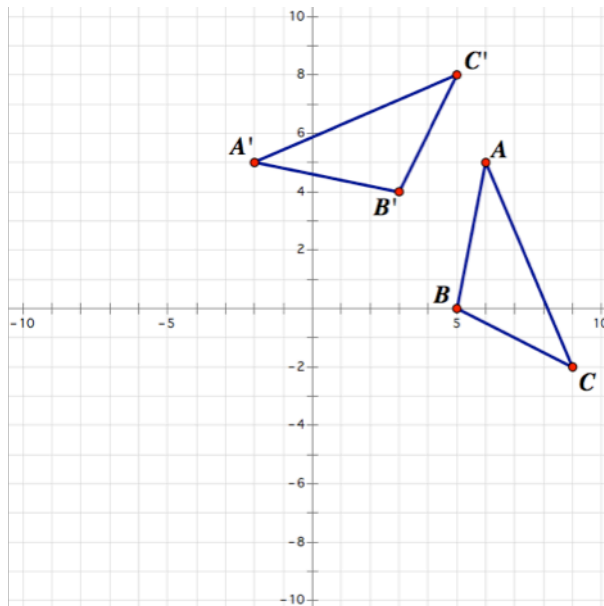

Carlos and Clarita think that the puzzle they have been given is too easy, since it only consists of a single rotated point and its pre-image.

Carlos: “The center of rotation is at the midpoint  $(2,4)$ , halfway between the image and pre-image points, and the point has been rotated  $180^\circ$ .”

Clarita disagrees: “The center of rotation is at the point  $(0, 0)$  since both the image and pre-image points are 5 units away from origin. I’ll need to use a protractor to find the angle of rotation.”



Laughing, Tehani says, “You’re both wrong. We didn’t use either  $(2, 4)$  or  $(0, 0)$  as the center of rotation when we created the puzzle.”

Carlos replies, “I can see how *both* of our points can be the center of rotation, but now I think that with a single image/pre-image pair of points *any* point can be the center of rotation.”

1. This puzzle has turned out to be more challenging than Carlos and Clarita thought. List at least three additional points that could be considered as the center of rotation, and justify your choices.
2. What do you think about Carlos’ last statement, “Any point can be the center of rotation”? Do you agree or disagree? If you agree, explain why any point works as the center of rotation for a single rotated point. If you disagree, what would be a better statement to make about the set of points that can be used as the center of rotation for a single rotated point and its pre-image?
3. Now examine the puzzle Carlos and Clarita gave to Travis and Tehani. Find the center of rotation for this puzzle; or, if you believe there can be more than one center of rotation, describe how all of the possible centers of rotation are related.
4. Using correct mathematical vocabulary, describe and illustrate your process for finding the center of rotation of a figure consisting of several image/pre-image pairs of points. If you make any claims in your description make sure you provide a proof of your claims.

Here are some words and their definitions for terms associated with circles. Some of these terms may be useful in your written description of how to find the center of rotation.

*Circle*—the set of all points in a plane equidistant from a fixed point called the center of the circle.

*Concentric circles*—a set of different circles that share the same center.

*Chord*—a line segment whose endpoints lie on a circle.

*Secant*—a line that intersects a circle at exactly two points.

*Tangent*—a line that intersects a circle at exactly one point.

© 2013 Mathematics Vision Project | MVP

In partnership with the Utah State Office of Education

Licensed under the Creative Commons Attribution-NonCommercial-ShareAlike 3.0 Unported license.





*Diameter*—a chord that passes through the center of a circle.

*Radius*—a line segment with one endpoint at the center of a circle and the other endpoint on the circle.

Note: the words *radius* and *diameter* also are used to refer to the lengths of these segments.

*Arc*—a portion of a circle.

*Central angle*—an angle whose vertex is at the center of a circle and whose sides pass through a pair of points on the circle.

*Inscribed angle*—an angle formed when two secant lines, or a secant and tangent line, intersect at a point on a circle.

*Intercepted arc*—the portion of a circle that lies between two lines, rays or line segments that intersect the circle.

(Note: Not all of these words will be useful for answering question 4, but they will be useful in future tasks, so they are given here for reference.)

5. Prove the following theorem: *The perpendicular bisector of a chord bisects the central angle formed by the radii drawn to the endpoints of the chord.*



# 7.1 Centered – Teacher Notes

## *A Develop Understanding Task*

---

**Purpose:** In this task students are asked to develop a strategy for locating the center of a rotation, which leads to the observation that the center of rotation lies on the perpendicular bisector of the segments joining image/pre-image pair of points. Such segments are defined to be chords of the circles on which the image/pre-image points lie. This work provides a method for finding the center of a circle. Students should also be able to prove that the perpendicular bisector of a chord contains a diameter of the circle and that the central angle formed by the radii that pass through the endpoints of the chord is bisected by the perpendicular diameter.

### **Core Standards Focus:**

**G.C.2** Identify and describe relationships among inscribed angles, radii, and chords. Include the relationship between central, inscribed, and circumscribed angles; inscribed angles on a diameter are right angles; the radius of a circle is perpendicular to the tangent where the radius intersects the circle.

**G.CO.9** Prove theorems about lines and angles. Theorems include: points on a perpendicular bisector of a line segment are exactly those equidistant from the segment's endpoints.

### **Related Standards:**

#### **Launch (Whole Class):**

Read through the story context at the beginning of this task with your students, and point out that they will be working on the same two puzzles that are given in the task. Have three different students take on the roles of Carlos, Clarita and Tehani and read through the dialog following the description of the puzzles. Assign students to work with a partner on questions 1-4.

#### **Explore (Small Group):**

In task 5.2, *Do You See What I See?*, students proved that points on the perpendicular bisector of a line segment are equidistant from the endpoints of the line segment. In question 2 of this task they should prove the converse of that statement—the points equidistant from the endpoints of a segment lie on the perpendicular bisector of the segment. Listen for students who are generating a “proof-like” argument in their work on questions 1 and 2. For the specific case presented in Travis and Tehani’s diagram, a proof might consist of the following statements: Carlos and Clarita have already verified that the points  $(2, 4)$  and  $(0, 0)$  are equidistant from  $A$  and  $A'$ . Consider the triangle whose vertices are at  $(0, 0)$ ,  $(2, 4)$  and  $A$ , and the triangle whose vertices are at  $(0, 0)$ ,  $(2, 4)$  and  $A'$ . These two triangles are congruent by SSS. The corresponding angles of these two triangles that share a vertex at  $(2, 4)$  are congruent and form a straight angle, therefore, they are right angles. Since the line through the points  $(0, 0)$  and  $(2, 4)$  also passes through the midpoint of segment  $AA'$ ,



it is the perpendicular bisector of that segment. Identify a student who can present this argument during the whole class discussion.

In question 3 watch for the strategy to emerge of drawing line segments between image/pre-image pairs of points and then drawing the perpendicular bisectors of those line segments. The three perpendicular bisectors will be concurrent at a single point, the center of the rotation. Identify a student who can present this strategy during the whole class discussion.

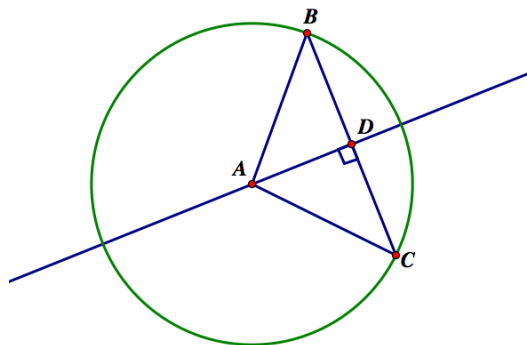

For question 5, watch for students who draw a diagram similar to the one at the left to illustrate this problem. Students should identify the two congruent triangles formed by the radii, the chord, and the perpendicular bisector to the chord. In this diagram,  $\triangle ABD$  and  $\triangle ACD$  are congruent by SSS. Therefore,  $\angle DAB$  and  $\angle DAC$  are congruent because they are corresponding parts of congruent triangles. This proves that we have bisected  $\angle BAC$ . Identify a student who can share a proof of this theorem during the whole class discussion.

### Discuss (Whole Class):

Begin the whole class discussion by reviewing the definitions of the terms listed in question 4. Many of these words will be familiar, but some new terms for students may include chord, secant line, tangent line, central angle, inscribed angle, and intercepted arc. Have students provide illustrations of each of these terms based on the definitions. Have students record these terms in their notebooks or on a word wall.

Have selected students present their work on question 2, question 3 and question 5. For question 2, generalize this proof beyond the specific case given by Travis' and Tehani's puzzle. Following the discussion on question 3, ask students to describe a general strategy for locating the center of a rotation.

As a follow-up to the work of this task, ask students to describe a general strategy for finding the center of a circle. (For example, draw two chords and their perpendicular bisectors. The two perpendicular bisectors will intersect at the center of the circle.)

### Aligned Ready, Set, Go: Circles: a Geometric Perspective 7.1



Name: \_\_\_\_\_

# Circles: a Geometric Perspective 7.1



©2013 www.flickr.com/photos/theknowledgallery

## Ready, Set, Go!

### Ready

Topic: Scale factor, center of dilation

For each pre-image and image determine the scale factor between the two figures.

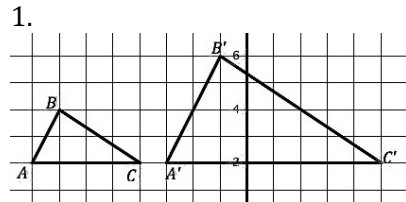

Scale Factor: \_\_\_\_\_

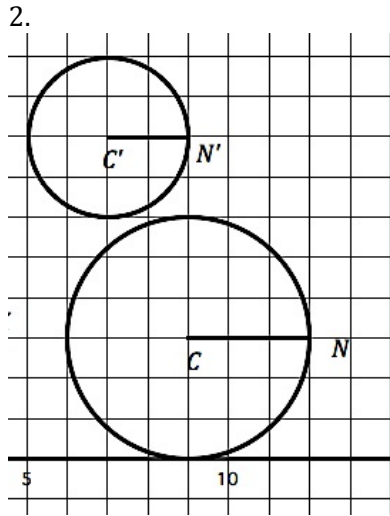

Scale Factor: \_\_\_\_\_

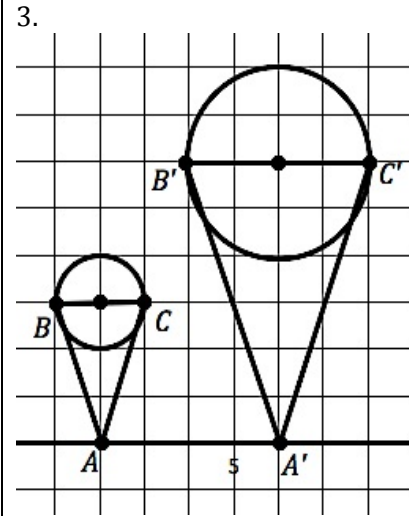

Scale Factor: \_\_\_\_\_

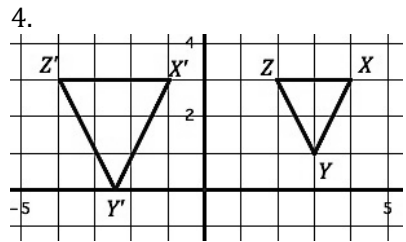

Scale Factor: \_\_\_\_\_

Each pre-image below is the result of a dilation. For each pair of figures given determine the coordinates for the center of dilation.

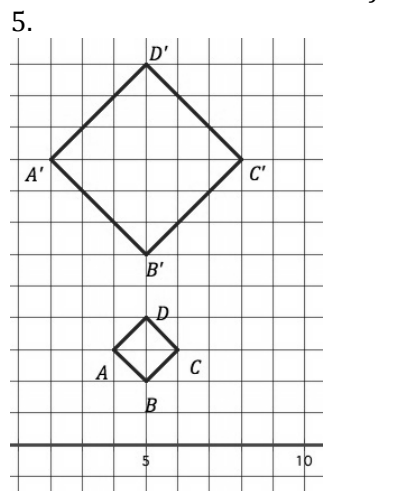

Center of dilation: \_\_\_\_\_

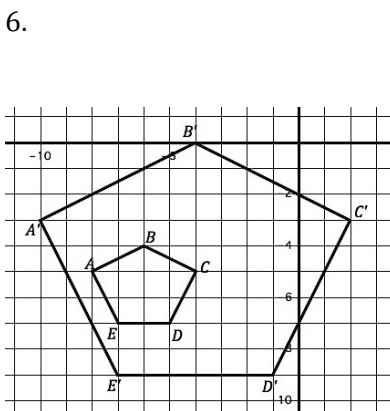

Center of dilation: \_\_\_\_\_

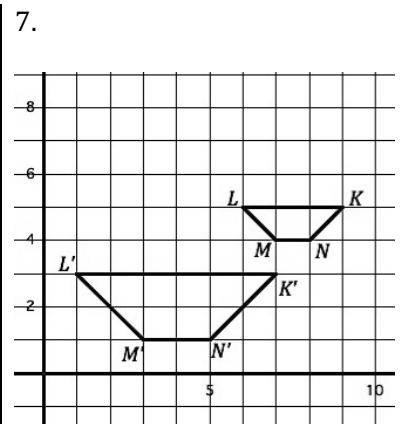

Center of dilation: \_\_\_\_\_



# Circles: a Geometric Perspective | 7.1

## Set

Topic: Finding the center of rotation.

**In each figure find and mark at least four possible centers of rotation that would work for rotating the image point to the pre-image point.**

8.

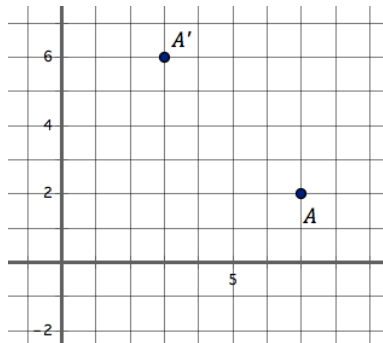

Centers of rotation:

9.

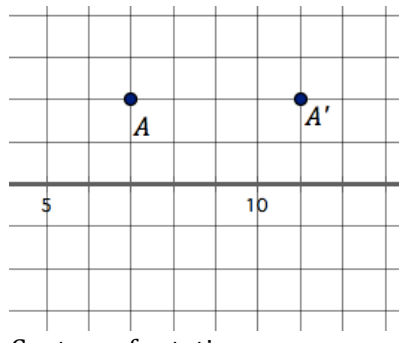

Centers of rotation:

10.

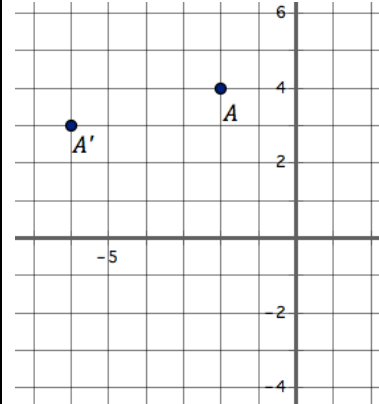

Centers of rotation

**In each figure below a rotation was done to produce the image, find the center of rotation.**

12.

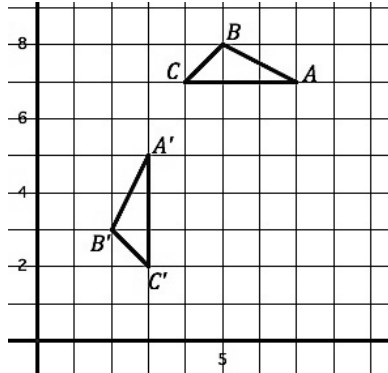

Center of rotation:

13.

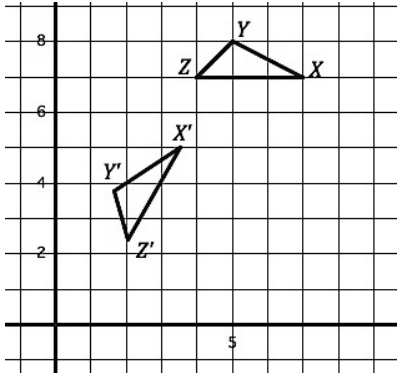

Center of rotation:

14.

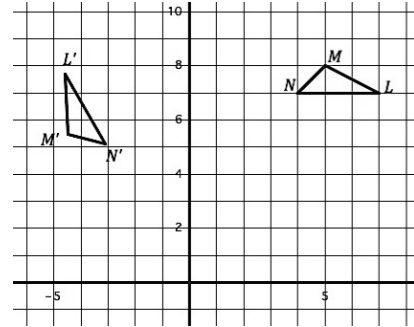

Center of rotation



**Go**

Topic: Finding circumference and area for circles.

Find the area and circumference of the given circles.

15.

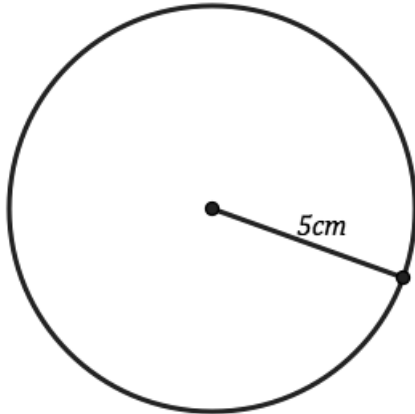

16.

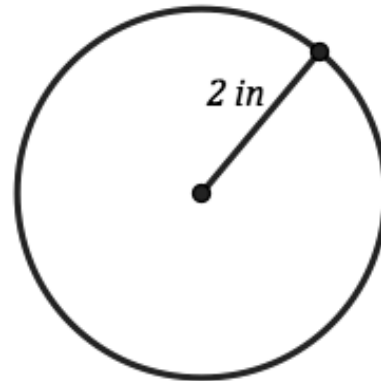

17. Find the circumference and area for the circles below and compare the results carefully

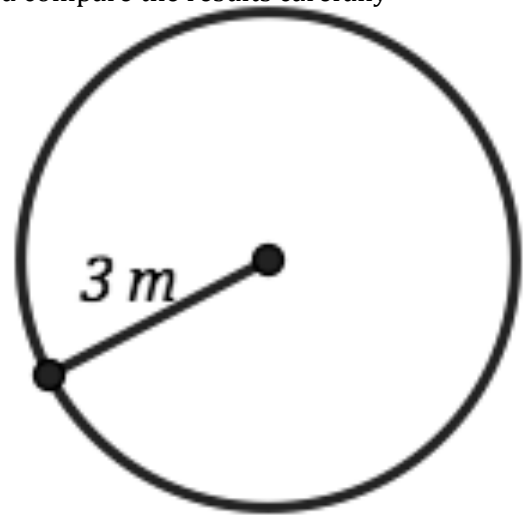
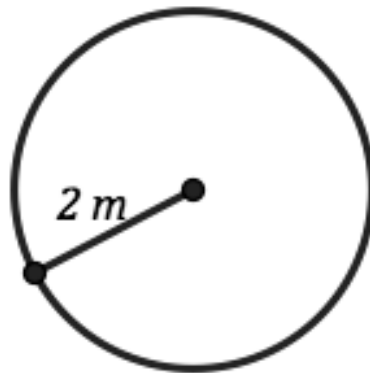
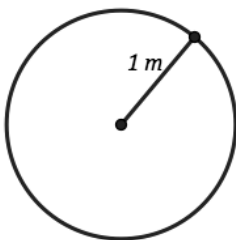

Radius	1m	2m	3m
Area			
Circumference			

How do they compare?



## 7.2 Circle Dilations

### *A Develop Understanding Task*

The statement “*all circles are similar*” may seem intuitively obvious, since all circles have the same shape even though they may be different sizes. However, we can learn a lot about the properties of circles by working on the proof of this statement.

Remember that the definition of similarity requires us to find a sequence of dilations and rigid motion transformations that superimposes one figure onto the other.

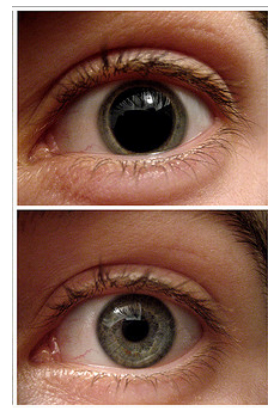

©2013 www.flickr.com/photos/trevy

Zac is describing to Sione how he would prove that circle  $A$  is similar to circle  $B$ .

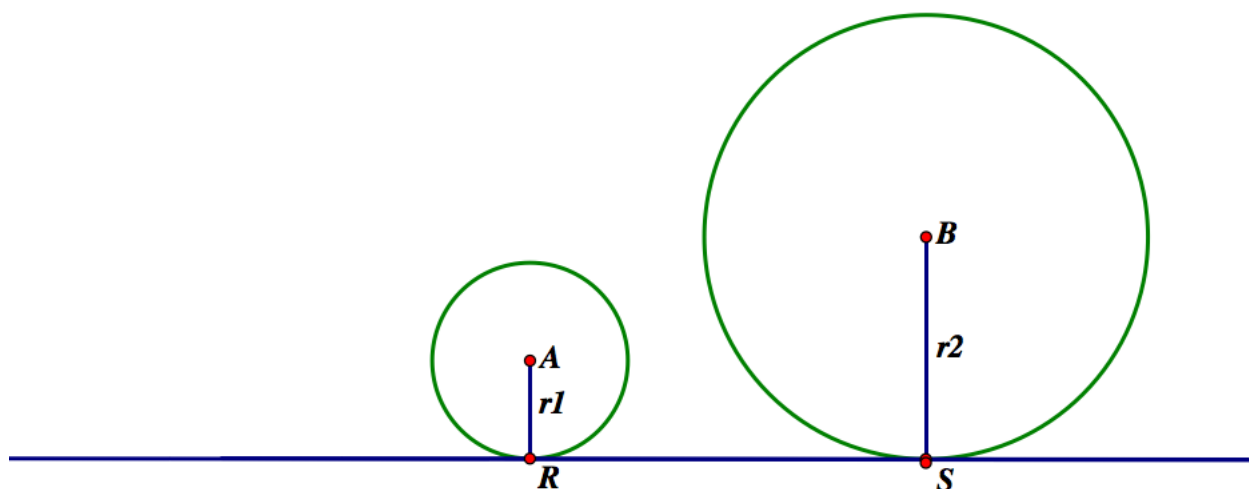

Zac: “Translate circle  $A$  until its center coincides with the center of circle  $B$ . Then enlarge circle  $A$  by dilation until the points on circle  $A$  coincide with the points on circle  $B$ . Or, you could shrink circle  $B$  by dilation until the points on circle  $B$  coincide with the points on circle  $A$ .”

Sione has some questions: “After the translation, what is the scale factor for the enlargement that carries circle  $A$  onto circle  $B$ ? And, what is the scale factor for the reduction that carries circle  $B$  onto circle  $A$ ?”

1. How would you answer Sione’s questions?



Based on Zac and Sione's discussion, we are probably convinced that circle  $A$  and circle  $B$  are similar. Another way we might convince ourselves that the two circles are similar would be to find the center of dilation that maps pre-image points from circle  $A$  onto corresponding image points on circle  $B$ .

2. Locate the center of dilation that carries circle  $A$  onto circle  $B$ . Explain how you know the point you found is the center of dilation. (Note that both circles have been drawn tangent to  $\overline{RS}$ .)
3. Draw some chords, triangles or other polygons in each circle that would be similar to each other. Explain how you know these corresponding figures are similar.
4. Based on the figures you drew in question 3, write some proportionality statements that you know are true.
5. Here is a proportionality statement you may not have considered. What convinces you that it is true?

$$\frac{\text{circumference of circle } A}{\text{diameter of circle } A} = \frac{\text{circumference of circle } B}{\text{diameter of circle } B}$$

Since this ratio of circumference to diameter is the same scale factor for all circles, this ratio has been given the name  $\pi$  (pi).

6. How much larger is the circumference of circle  $B$  than the circumference of circle  $A$ ?
7. Do you think the following proportion is true or false? Why?

$$\frac{\text{area of circle } B}{\text{area of circle } A} = \frac{\text{circumference of circle } B}{\text{circumference of circle } A}$$





# 7.2 Circle Dilations – Teacher Notes

## *A Develop Understanding Task*

---

**Note to teachers:** You may want to provide students with several copies of the diagram in the task to facilitate multiple drawings in response to question 3.

**Purpose:** In this task students consider the similarity of circles by examining two different transformation strategies that map one circle onto another. In the first strategy one circle is translated so that the center of the circles coincide. The inner circle can then be enlarged to carry it onto the outer circle, or the outer circle can be shrunk to carry it onto the inner circle. Students are asked to determine the scale factors for both the enlargement and the reduction. In the second strategy students observe that any circle can be mapped onto any other circle by dilation. Students are also asked to find the scale factor of this dilation, which is the same scale factor as the enlargement (or reduction) factor used in the first strategy. Students are also given the opportunity to draw similar figures inscribed within the two circles, which has the potential of surfacing some observations about central and inscribed angles, and the relationship between tangent lines and radii.

### **Core Standards Focus:**

**G.C.1** Prove that all circles are similar.

### **Related Standards: G.C.2**

### **Launch (Whole Class):**

Students should have access to this task based on the work with dilations in module 6. After posing the main question to be explored in this task, “Are all circles similar?”, set students to work on the task.

### **Explore (Small Group):**

Students may be confused about finding the scale factors asked for in question 1, since no numbers are given. Ask what they would do if the specific radii of the two circles were given. Help students recognize the scale factor for the enlargement would be  $\frac{r_2}{r_1}$  and for the reduction it would be  $\frac{r_1}{r_2}$

For question 2 students need to recognize that the line  $RS$  will pass through the center of dilation, as will the line  $AB$  which contains the centers of the circles, since both lines map a point on circle  $A$  to its image on circle  $B$ . The point of intersection of these two lines will be the center of dilation.

Question 3 may challenge students until they realize that any line through the center of dilation will map points on circle  $A$  to their images on circle  $B$ . Such secant lines will identify vertices of similar figures that can be inscribed in circle  $A$  and circle  $B$ . Therefore, encourage students to focus on

© 2013 Mathematics Vision Project | MVP

In partnership with the Utah State Office of Education

Licensed under the Creative Commons Attribution-NonCommercial-ShareAlike 3.0 Unported license.



inscribed triangles and inscribed polygons—figures that have their vertices on the circles—so they can map corresponding pre-image points to image points in the other circle. Once students have created one or more inscribed polygons that are similar to each other, they should be able to write some proportionality statements for question 4. Watch for two types of proportionality statements: ones where the ratios consist of two segments from the same figure, and ones where the ratios consist of corresponding segments from similar figures.

In question 6 help students recognize that while the ratio of circumference to diameter of each circle is  $\pi$ , the ratio of the circumference of the larger circle to the circumference of the smaller circle is  $\frac{r_2}{r_1}$ .

To help resolve question 7 you may refer back to task 6.1, *Photocopy Faux Pas*, where it was observed that the scale factor for area is the square of the scale factor for a line segment. Since the circumference is a linear measurement, the ratio of the areas of the circles will be the square of the ratio of the circumferences.

**Discuss (Whole Class):**

Much of the whole class discussion should focus on the similar figures students created for question 3 in order to talk about inscribed angles and intercepted arcs, and possibly surface the relationship between inscribed angles and central angles. Pose a possible pair of similar figures such as the following (or use a student-generated pair of similar figures that will get at these same issues).

Ask students to identify some similar triangles in this diagram. Use these triangles to write some proportionality statements.

Ask students to identify some isosceles triangles in this diagram and explain how they know they are isosceles.

Ask students to identify any inscribed angles.

Ask students to identify any central angles and point out that a central angle and the intercepted arc have the same degree measure.

Ask students if they think there are any right triangles in this figure, and why they think it contains a right angle.

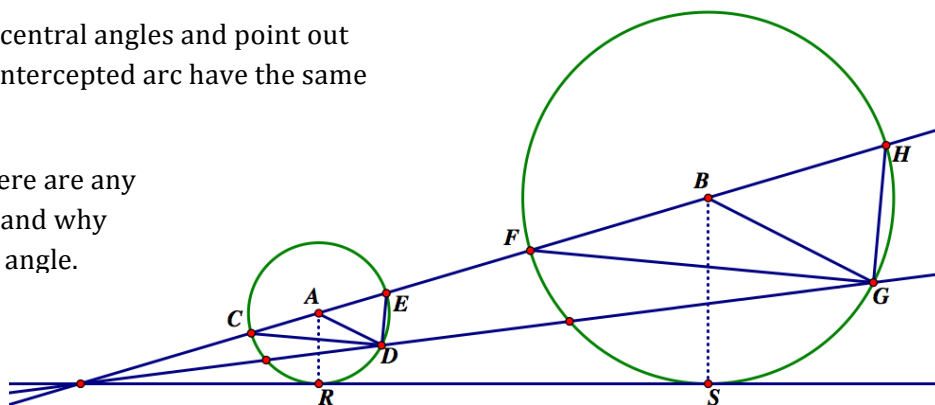

Students may suggest that  $\triangle HGF$  is a right triangle by the way it looks. Point out that  $\angle HGF$  is an inscribed angle that intercepts the semicircular arc  $FH$  and that the triangle is inscribed in a semicircle. If  $\angle HGF$  is a right angle, then it measures half of the  $180^\circ$  arc it intercepts.

Either end the discussion with this last observation, which will be revisited in the next task, or you may choose to continue this discussion about the relationship between inscribed angles and their intercepted arcs. If you choose to continue the discussion, label the angles of the triangles in circle  $B$  as shown in the following diagram. Ask students the following questions to generate a conjecture and proof about the relationship between the degree measure of an inscribed angle and its intercepted arc:

How do we know  $x = y$ ? (Because  $\triangle BFG$  is isosceles.)

How do we know  $w = x + y$ ? (An external angle of a triangle measures the sum of the two remote interior angles.)

What does this imply about the relationship between  $x$  and  $w$ ? (By substitution,  $w = 2x$  or  $x = \frac{1}{2}w$ .)

What does this imply about the relationship between an inscribed angle and its intercepted arc?

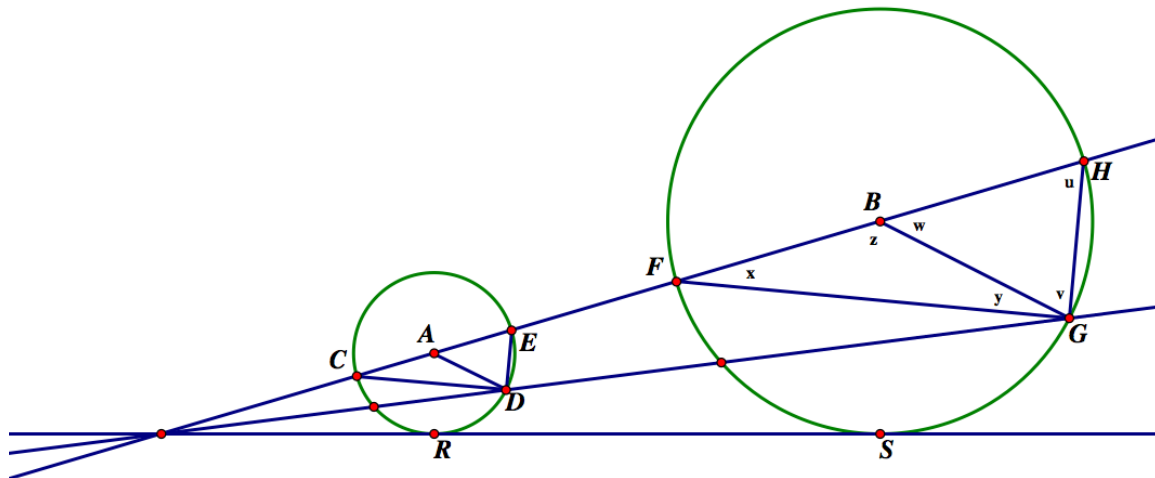

### Aligned Ready, Set, Go: Circles: a Geometric Perspective 7.2



Name: \_\_\_\_\_

Circles: a Geometric Perspective | 7.2

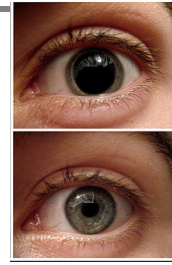

Ready, Set, Go!

©2013 www.flickr.com/photos/trevy

Ready

Topic: Finding missing angles, rotational symmetry, regular polygons

Find the missing angle in each of the figures below.

1.

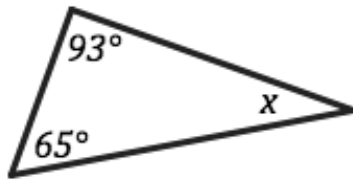

$m\angle x =$

2.

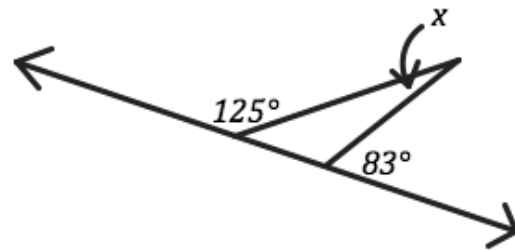

$m\angle x =$

3.

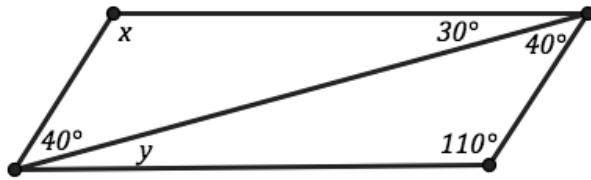

$m\angle x =$       $m\angle y =$

4.

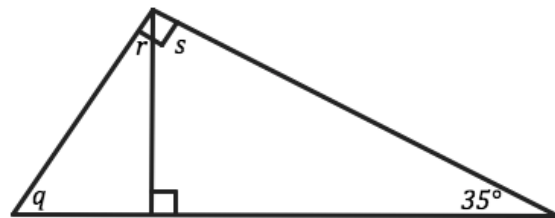

$m\angle q =$       $m\angle r =$       $m\angle s =$

Find the angles of rotational symmetry for the regular polygons. Rotational symmetry means that the polygon rotates the indicated number of degrees to land on itself and all points in the image coincide with the pre-image.

5.

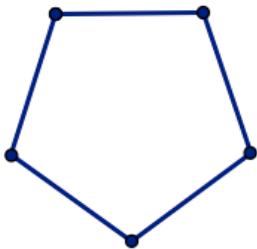

6.

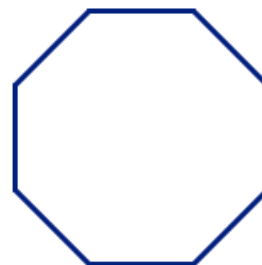

**Set**

Topic: Dilations, proportionality between similar figures.

For each set of similar figures complete the proportionality statements.

7.  $\triangle ABC \sim \triangle CDE$

a.  $\frac{AB}{CD} = \frac{BC}{?}$

b.  $\frac{AC}{AB} = \frac{?}{CD}$

c.  $\frac{BC}{AC} = \frac{DE}{?}$

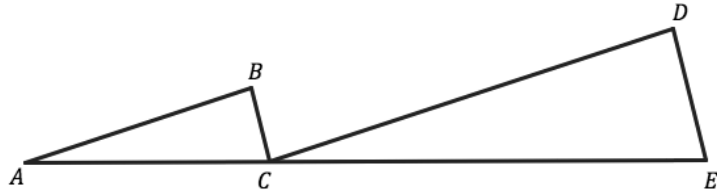

8a.  $\frac{AB}{\widehat{BC}} = \frac{?}{\widehat{B'C'}}$

b.  $\frac{\widehat{BC}}{\widehat{B'C'}} = \frac{?}{?}$

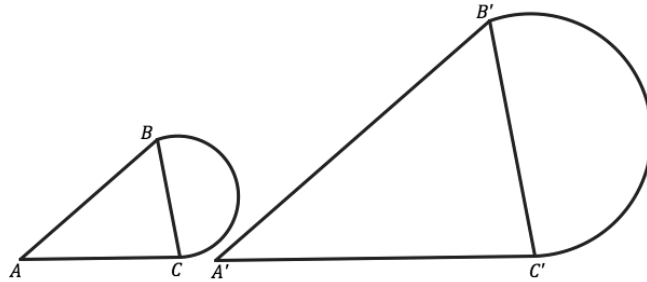

9. Quadrilateral ABCD ~ Quadrilateral EFGH

a.  $\frac{\widehat{EF}}{?} = \frac{GH}{CD}$

b.  $\frac{\text{Circumference Large Circle}}{\text{Circumference Small Circle}} = \frac{?}{?}$

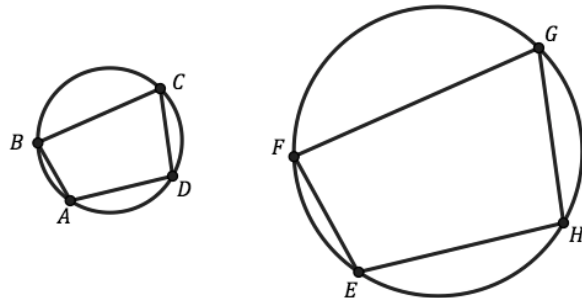

**Go**

Topic: Finding lines of reflection, finding the center of a circle.

**Find the line of reflection between the image and the pre-image.**

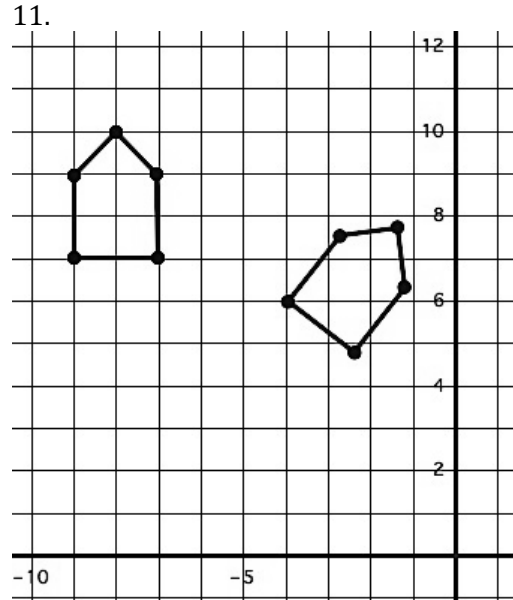
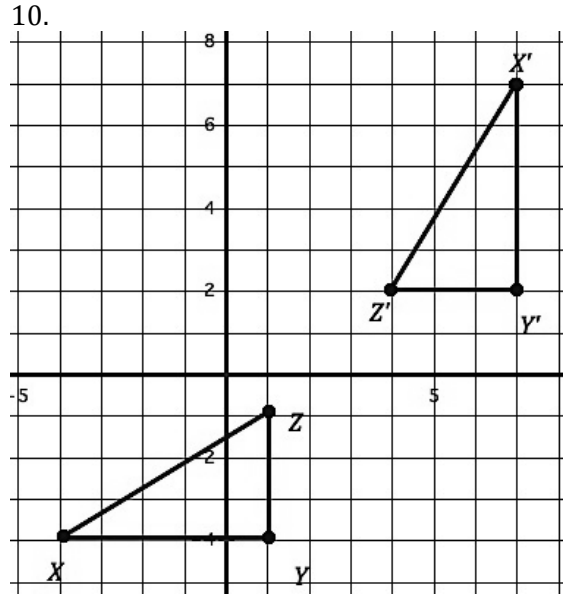

**Find the center of each circle. (Hint: rotations happen on circles and so finding the center of a circle is like finding the center of rotation between pairs of point on the circle.)**

12. Use the given chords to assist you.

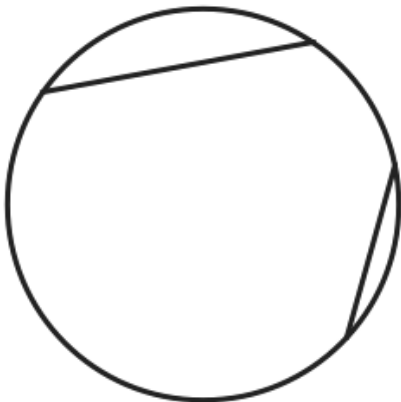

13. Draw two chords to assist you.

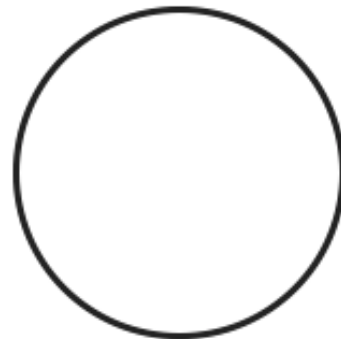

## 7.3 Cyclic Polygons

### *A Solidify Understanding Task*

By definition, a cyclic polygon is a polygon that can be inscribed in a circle. That is, all of the vertices of the polygon lie on the same circle.

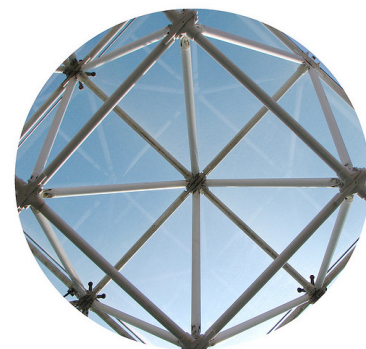

©2013 www.flickr.com/photos/fdecomite

#### **Part 1**

In task 5.8 *Centers of a Triangle* your work on Kara's notes and diagram should have convinced you that it is possible to locate a point that is equidistant from all three vertices of any triangle, and therefore all triangles are cyclic polygons.

1. Based on Kara's work, use a compass and straightedge to construct the circles that contain all three vertices in each of the following triangles.

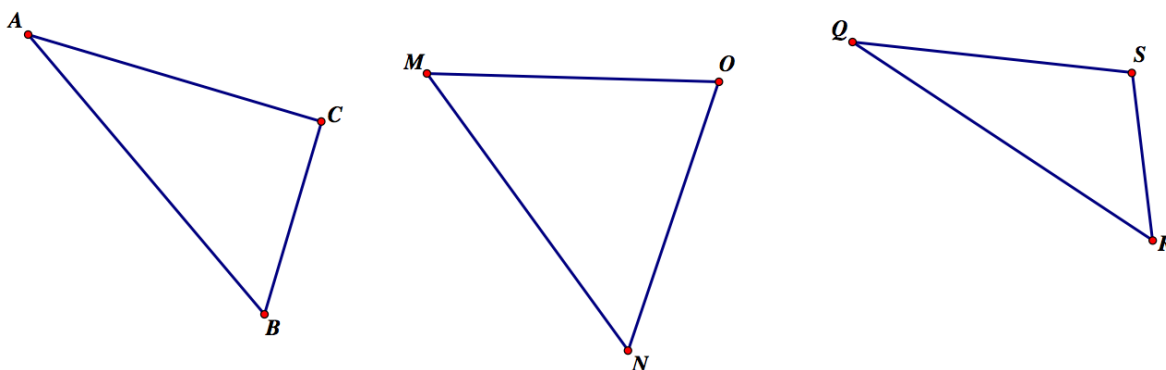

Since each vertex of an inscribed triangle lies on the circle, each angle of the triangle is an inscribed angle. We know that the sum of the measures of the interior angles of the triangle is  $180^\circ$  and that the sum of the measures of the three intercepted arcs is  $360^\circ$ .

2. Using one of the diagrams of an inscribed triangle you created above, illustrate and explain why this last statement is true.

We know that the degree measure of an arc is, by definition, the same as the measure of the central angle formed by the radii that contain the endpoints of the arc. But how is the measure of an inscribed angle that intercepts this same arc related to the measure of the central angle and the intercepted arc? That is something useful to find out.

3. Using a protractor, find the measure of each arc represented on each circle diagram above. Then find the measure of each corresponding inscribed angle. Make a conjecture based on this data.



My conjecture about the measure of an inscribed angle:

The three circle diagrams you created above have been reproduced below. One inscribed angle has been bolded in each triangle. A diameter of the circle has also been added to each diagram as an auxiliary line segment, as well as some additional line segments that will assist in writing proofs about the inscribed angles. Three cases are illustrated: case 1, where the diameter is a side of the inscribed angle; case 2, where the diameter lies in the interior of the inscribed angle; and case 3, where the diameter lies in the exterior of the inscribed angle. In each diagram, prove your conjecture for the inscribed angle shown in bold.

Case 1:

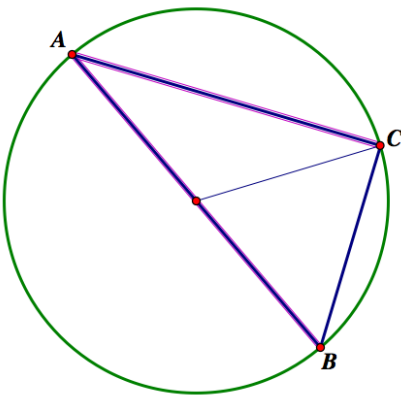

Case 2:

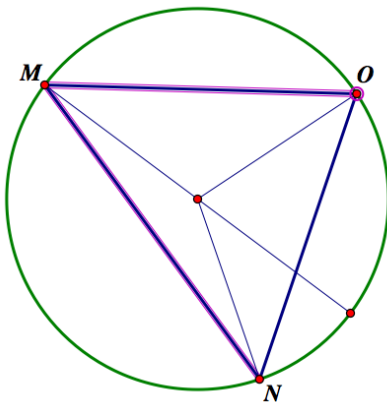



Case 3:

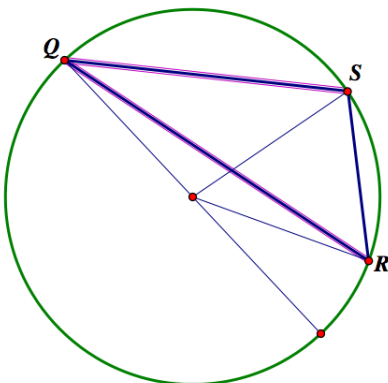

## **Part 2**

We have found that all triangles are cyclic polygons. Now let's examine possible cyclic quadrilaterals.

4. Using dynamic geometry software, experiment with different types of quadrilaterals. Based on your experimentation, decide which word best completes each of the following statements:
  - a. [Some, all, no] squares are cyclic.
  - b. [Some, all, no] rhombuses are cyclic.
  - c. [Some, all, no] trapezoids are cyclic.
  - d. [Some, all, no] rectangles are cyclic.
  - e. [Some, all, no] parallelograms are cyclic.

Obviously, some generic quadrilaterals are cyclic, since you can select any four points on a circle as the vertices of a quadrilateral.

5. Using dynamic geometry software, experiment with cyclic quadrilaterals that are not parallelograms or trapezoids. Focus on the measurements of the angles. Make a conjecture about the measures of the angles of a cyclic quadrilateral. Then prove your conjecture using what you know about inscribed angles.



My conjecture about the angles of a cyclic quadrilateral:

Proof of my conjecture:

(How might you use the following diagram to assist you in your proof?)

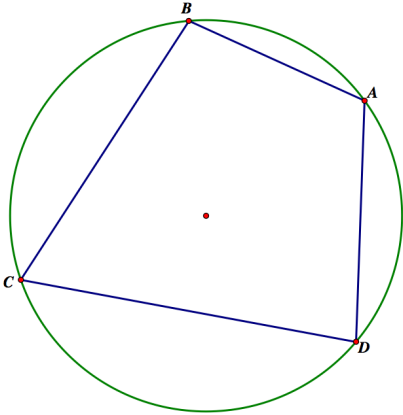

### Part 3

In task 5.8 *Centers of a Triangle*, your work on Kolton's notes and diagram should have convinced you that it is possible to locate a point that is equidistant from all three sides of a triangle, and therefore a circle can be inscribed inside every triangle.

6. Based on Kolton's work, use a compass and straightedge to construct the circles that can be inscribed in each of the following triangles.

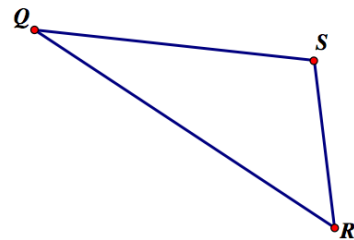
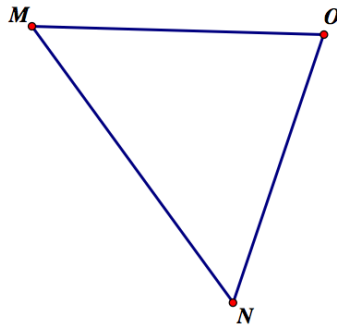
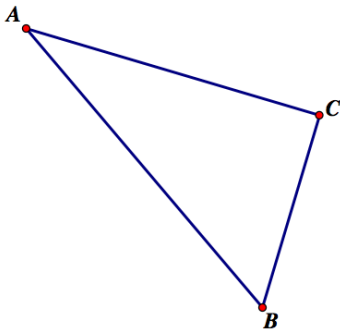

© 2013 Mathematics Vision Project | MVP

In partnership with the Utah State Office of Education

Licensed under the Creative Commons Attribution-NonCommercial-ShareAlike 3.0 Unported license.



7. The angles of the triangle that are formed by the lines that are tangent to the circle are called circumscribed angles. Use dynamic geometry software to experiment with the measures of circumscribed angles relative to the arcs they intercept. Make a conjecture about the measures of the circumscribed angles. Then prove your conjecture using what you know about inscribed angles.

My conjecture about the measures of circumscribed angles:

Proof of my conjecture:

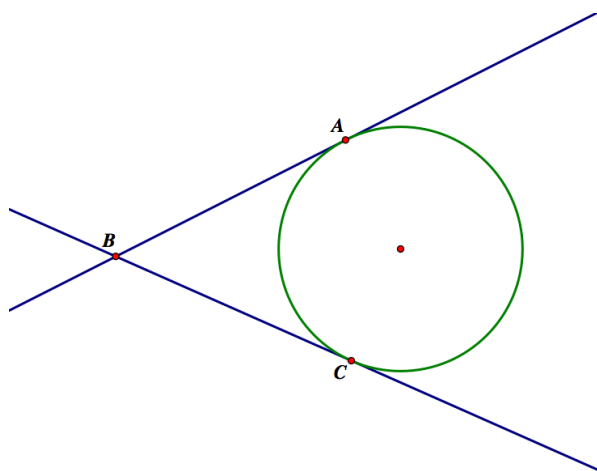

8. Based on your work in this task and the previous task, describe a procedure for constructing a tangent line to a circle through a given point outside the circle.



# 7.3 Cyclic Polygons – Teacher Notes

## *A Solidify Understanding Task*

---

**Note to the teacher:** Students will need to reference their work from task 7.2, *Circle Dilations*, and 5.8, *Centers of a Triangle*, as they work on this task. Students will need to have access to dynamic geometry software for parts 2 and 3 of this task.

**Purpose:** In the context of constructing circumscribed and inscribed circles for a triangle, students make observations about the relationships between central angles, inscribed angles and circumscribed angles. These observations are used to prove that angles inscribed in a semicircle are right angles, opposite angles of inscribed quadrilaterals are supplementary, and a tangent line to a circle is perpendicular to the radius drawn to the point of tangency.

### **Core Standards Focus:**

**G.C.2** Identify and describe relationships among inscribed angles, radii, and chords. Include the relationship between central, inscribed, and circumscribed angles; inscribed angles on a diameter are right angles; the radius of a circle is perpendicular to the tangent where the radius intersects the circle.

**G.C.3** Construct the inscribed and circumscribed circles of a triangle, and prove properties of angles for a quadrilateral inscribed in a circle.

**G.C.4** Construct a tangent line from a point outside a given circle to the circle.

### **Related Standards:**

#### **Launch (Whole Class): [part 1]**

Remind students of their work with inscribed angles and inscribed polygons from the previous task. Also have students review their work on 5.8, *Centers of a Triangle*, and how they were able to locate the centers of a circumscribed circle and an inscribed circle based on their work in that task. Set the purpose for this task by reading through the following statement with students (this statement appears between questions 2 and 3 in the task). Illustrate this statement with a diagram.

*We know that the degree measure of an arc is, by definition, the same as the measure of the central angle formed by the radii that contain the endpoints of the arc. But how is the measure of an inscribed angle that intercepts this same arc related to the measure of the central angle and the intercepted arc? That is something useful to find out.*

Once students understand the question they are to explore, set them to work on the task.

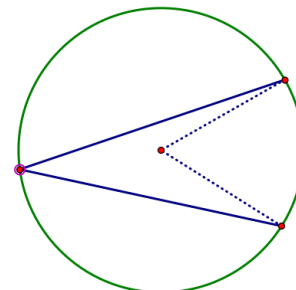

Name: \_\_\_\_\_

## Circles: a Geometric Perspective | 7.3

## Ready, Set, Go!

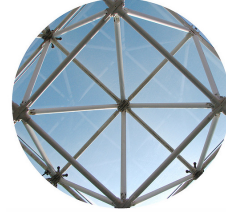

## Ready

Topic: Symmetry, Trigonometric Ratios

©2013 www.flickr.com/photos/fdecomite

**Determine the angles of rotational symmetry and the number of lines of reflective symmetry for each of the polygons below.**

1. Equilateral Triangle

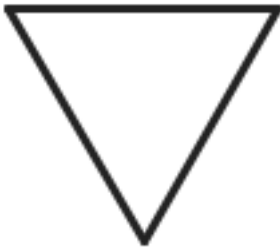

2. Rectangle



3. Rhombus

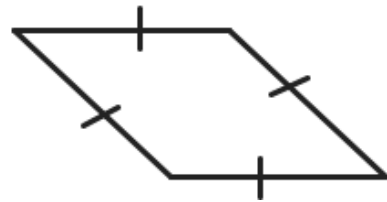

4. Regular Hexagon



5. Square

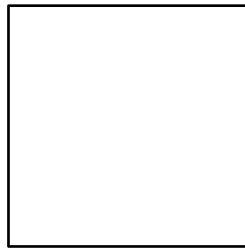

6. Decagon

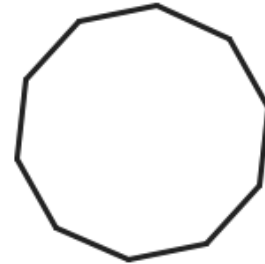

**Solve each right triangle, give the missing angles and sides.**

7.



8.



9.

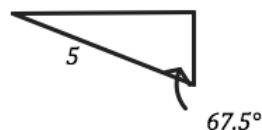

10.

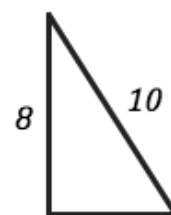

**Set**

Topic: Angles and how they connect with arcs.

**Find the value of the angle or the intercepted arc indicated in each figure below.**

11.  $\odot M$  with  $m\angle LMN=110^\circ$

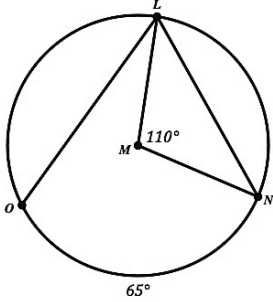

- a.  $m\widehat{LN} =$
- b.  $m\angle OLN =$
- c.  $m\widehat{OL} =$

12.  $\odot B$  with  $m\angle ABC=130^\circ$

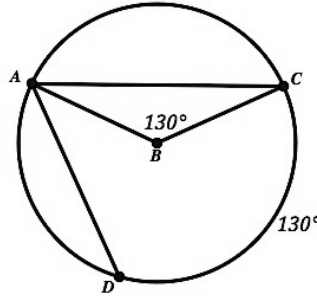

- a.  $m\widehat{AC} =$
- b.  $m\angle CAD =$
- c.  $m\widehat{DA} =$

13.  $\odot F$

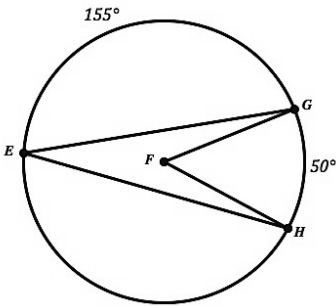

- a.  $m\widehat{EG} =$
- b.  $m\widehat{EHG} =$
- $m\angle GEH =$
- $m\angle GFH =$

14.  $\odot M$  with diameter  $\overline{NK}$

- a.  $NK =$   $NL=12$  and  $KL=5$

- b.  $m\widehat{NLK} =$
- c.  $m\widehat{NJK} =$
- d.  $m\angle NLK =$
- e.  $m\widehat{KL} =$
- f.  $m\widehat{NL} =$

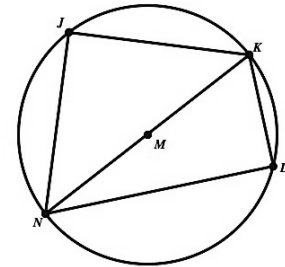

15. How can a triangle be used to show the connection between an inscribed angle and the angle measure of the arc it intercepts? What is true about the angle measure in any triangle? What is true about the arc measure for an entire circle?



**Go**

Topic: Finding lengths of arcs.

Use what you know about finding circumference,  $C=2\pi r$  and Area,  $A=\pi r^2$  for circles to find the indicated distances and areas below.

16.  $\odot R$  is cut by two diameters that are perpendicular to each other.

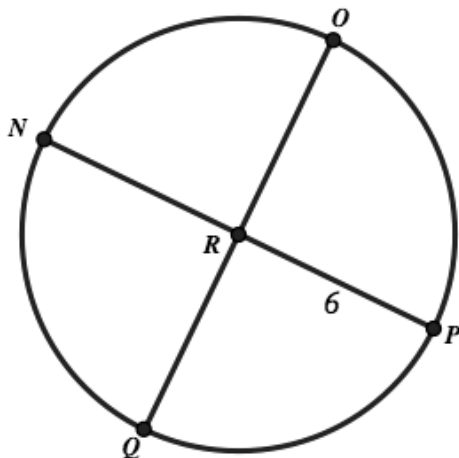

- Find the distance to walk along arc NQ
- Find the area inside one of the four sectors
- Find the distance to walk along the following path: Start at point P and go to R then to Q and over to N then back to P.

17.  $\odot S$  is cut by three diameters that create equal angles at the center of the circle.

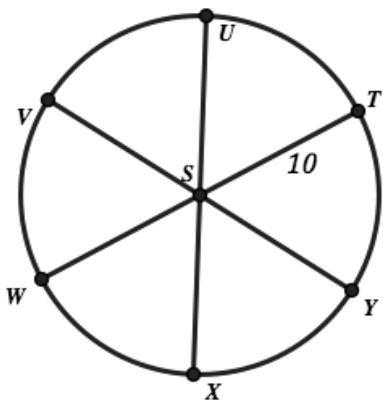

- Find the distance to walk along arc UT
- Find the area inside one of the six sectors
- Find the distance to walk along the following path: Start at point U go to S then to V then to W followed by X and then back to U.

Need Assistance? Check out these additional resources:

<http://www.mathopenref.com/arc.html>



# 7.4 Planning the Gazebo

## *A Develop Understanding Task*



Zac is using his knowledge of geometry to design a gazebo for his family’s back yard. The gazebo will be in the shape of a regular polygon. As part of his design, Zac will need to calculate several things so his parents can purchase the right amount of wood for the construction. For example, Zac will need to calculate the perimeter of the gazebo so he can order enough railing to surround it; he will need to calculate the area of the floor of the gazebo so he can order enough planks to lay it; and, he will need to calculate the surface area of the pyramid which forms the roof that will cover it. The problem is, his parents keep changing their minds about what shape they would like the gazebo be—a hexagon, an octagon, a decagon, a dodecagon, or even some other type of  $n$ -gon.

From his work in Mathematics I with *Symmetries of Regular Polygons*, Zac knows that all regular polygons are cyclic—that is, every regular polygon can be **inscribed** in a circle. Zac is wondering if he can use this property of regular polygons to help him find their perimeter and area.

For his first attempt at creating a scale drawing of the gazebo, Zac has inscribed a regular hexagon inside a circle with a radius of 2 inches. He is wondering if this is enough information to find the perimeter of this hexagon and the area it encloses.

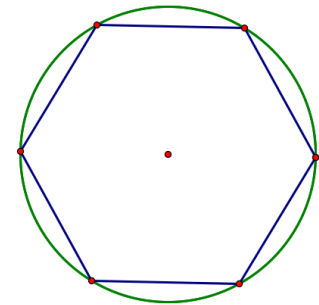

1. To get started with the task of finding the perimeter of this hexagon, Zac decides to write down what he already knows about this figure. Decide if you agree or disagree with each of his statements, and explain why. You will want to add features to the diagram to illustrate Zac’s comments.

What Zac thinks he knows:	Do you agree or disagree? Explain why.
Two radii drawn to two consecutive vertices of the regular hexagon form a central angle whose measure can be found based on the rotational symmetry of the figure.	
The hexagon can be decomposed into 6 congruent isosceles triangles.	
The length of the altitudes of each of these 6 congruent triangles (the altitude drawn from the vertex of the triangle which is located at the center of the circle) can be found using trigonometry.	





The length of the sides of the triangle that form chords of the circle can be found using trigonometry.	
---	--

- Based on what you and Zac know, find the perimeter of the hexagon that he inscribed in the circle with a radius of 2 inches. Illustrate and describe your strategy so someone else can follow it.
- Now find the area of the hexagon that Zac inscribed in the circle with a radius of 2 inches. Illustrate and describe your strategy so someone else can follow it.

- What if Zac had inscribed an octagon inside the circle of radius 2 instead of a hexagon? Modify your strategy to find the perimeter and area of the octagon.

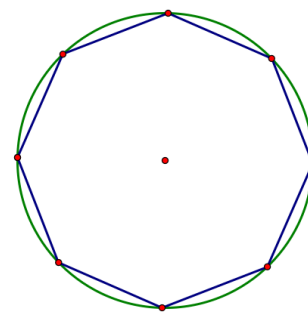

- Modify your strategy to find the perimeter and area of any regular  $n$ -gon inscribed in a circle of any given radius.

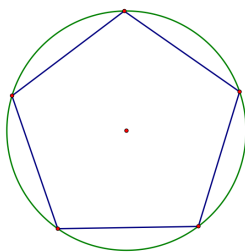
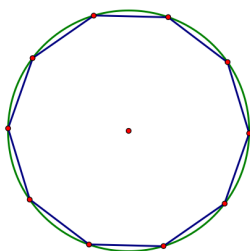

# 7.4 Planning the Gazebo – Teacher Notes

## *A Develop Understanding Task*

---

**Purpose:** In this task students will develop a strategy for finding the perimeter and area of regular polygons. This work will lead to informal arguments for the formulas of the circumference and area of a circle in the next task.

### **Core Standards Focus:**

**G.GMD.1** Give an informal argument for the formulas for the circumference of a circle, area of a circle, volume of a cylinder, pyramid, and cone. Use dissection arguments, Cavalieri’s principle, and informal limit arguments.

### **Related Standards:**

#### **Launch (Whole Class):**

Read through the story at the beginning of the task to give students a sense of the mathematics they will be working on—*developing a strategy for finding the perimeter and area of regular polygons*.

#### **Explore (Small Group):**

As students work on question 1 they need to do more than just say they agree with Zac’s ideas—they also need to illustrate what each idea means relative to the inscribed hexagon. Press students to explain their thinking by asking such questions as: How does rotational symmetry help you find the measures of the central angles? Why are the triangles that are formed by radii drawn to the vertices isosceles? Why are these triangles congruent? How can we use trigonometry to find the lengths of the altitudes of these triangles? How can we find the lengths of the chords of the circle that form the sides of the inscribed hexagon?

#### **Discuss (Whole Class):**

Select students to share their strategies for finding the perimeter of a regular polygon inscribed in a circle. Begin with strategies that can be expressed as a sequence of steps, and if possible, end with a student who can present a generalized formula.

Students might describe a strategy for finding the perimeter and area of an  $n$ -gon as follows: (ask students to justify each statement)

- Find the measure of a central angle formed by two consecutive radii by dividing  $360^\circ$  by  $n$ .
- Form a right triangle by drawing a radius from the center of the circle to a vertex of the  $n$ -gon, and drawing another segment from the center of the circle perpendicular to a side of the  $n$ -gon.



- The perpendicular segment drawn bisects the central angle, so we know one angle in the right triangle and can calculate the other angle from the fact that the sum of the angles in a triangle is  $180^\circ$ .
- Since we know the angles in the right triangle, we can use right triangle trigonometric ratios to find the lengths of both of the legs of this right triangle.
- The perimeter of the  $n$ -gon is  $2n$  times the length of the leg of the right triangle that lies on the perimeter.
- The area of the  $n$ -gon is  $2n$  times the area of one of the right triangles for which we have found the lengths of the two legs. These legs form the base and height of the right triangle, and therefore, we have the information we need to calculate the area of this right triangle.

**Aligned Ready, Set, Go: Circles: a Geometric Perspective 7.4**



Name: \_\_\_\_\_

## Circles: a Geometric Perspective | 7.4

## Ready, Set, Go!



©2013 www.flickr.com/photos/jill.kemerer

## Ready

Topic: Radius and Area or Circumference

**Given the area or circumference or radius find the other two.**

1.

$$\begin{aligned} \text{Radius} &= 1 \text{ m} \\ \text{Area} &= \\ \text{Circumference} &= \end{aligned}$$

2.

$$\begin{aligned} \text{Radius} &= \\ \text{Area} &= 9\pi \text{ ft}^2 \\ \text{Circumference} &= \end{aligned}$$

3.

$$\begin{aligned} \text{Radius} &= \\ \text{Area} &= \\ \text{Circumference} &= 8\pi \text{ yds} \end{aligned}$$

4.

$$\begin{aligned} R &= \\ A &= 3.14 \text{ m}^2 \\ C &= \end{aligned}$$

5.

$$\begin{aligned} R &= 7 \text{ miles} \\ A &= \\ C &= \end{aligned}$$

6.

$$\begin{aligned} R &= \\ A &= \\ C &= 81\pi \text{ in}^2 \end{aligned}$$

## Set

Topic: Finding area and perimeter of regular polygons.

**For each of the regular polygons find the measure of the interior angle, the perimeter and the area.**

7.



- Measure of one interior angle:
- Perimeter:
- Area:

8.

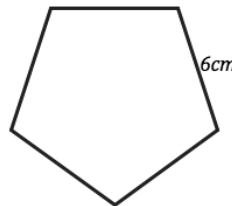

- Measure of one interior angle:
- Perimeter:
- Area:

9.

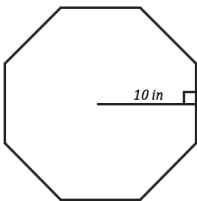

- Measure of one interior angle:
- Perimeter:
- Area:

10. A regular polygon with 14 sides. And one side equal to 6 inches.

- Measure of one interior angle:
- Perimeter:
- Area:



## Circles: a Geometric Perspective | 7.4

11. A 24-gon with sides equal to 12 meters.

a. Measure of one interior angle:

b. Perimeter:

c. Area:

12. A nonagon with sides equal to 8 yards.

a. Measure of one interior angle:

b. Perimeter:

c. Area:

## Go

Topic: Find area of a sector of a circle.

*If a circle is cut into for equal pieces then the area of one piece would clearly be one forth of the area of the entire circle. If a circle is cut into six equal pieces then the area of one of the pieces would be a sixth of the total area and so forth, for  $n$  equal pieces the area of one piece would be one  $n$ th of the total area. With this in mind consider the area of a sector that is one degree in size. A circle split into sectors that are all one degree in size would have 360 sectors. How could you find the area of just one of them?*

*Once you have one of them you could multiple it by any amount to find a sector of any number of degrees. Use this strategy to find the area of the sector of each circle on the next page. Use the example below to assist you.*

The area of the circle is  $9\pi \text{ in}^2$

So, a sector of one degree would have area  $\frac{9\pi}{360} \text{ in}^2$

And so the area of the sector with a central angle of  $80^\circ$

Would be  $(80) \frac{9\pi}{360}$  which simplifies to be  $2\pi \text{ in}^2$ .

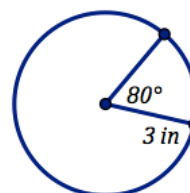

**Find the area of the sector indicated with the angle measure.**

13.

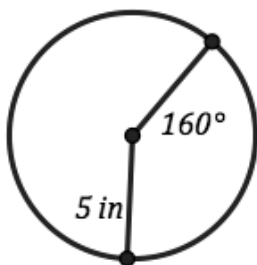

14.

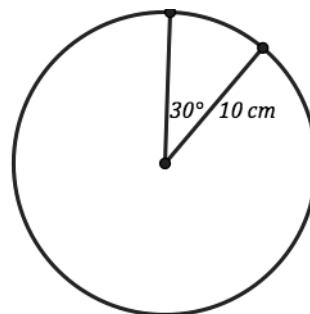

15.

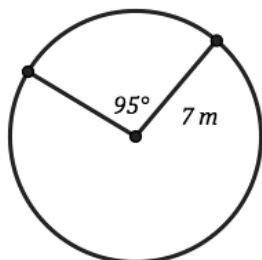

16.

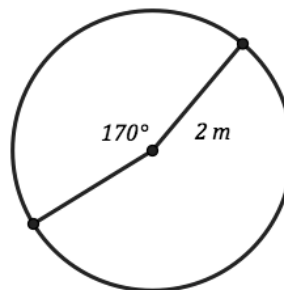

Need Assistance? Check out these additional resources:

<http://www.regentsprep.org/regents/math/geometry/GP14/CircleSectors.htm>



# 7.5 From Polygons to Circles

## A Solidify Understanding Task

### Part 1: From perimeter to circumference

In the previous task, *Planning the Gazebo*, you developed a strategy for finding the perimeter of a regular polygon with  $n$  sides inscribed in a circle of radius  $r$ . Tehani's strategy consists of the following formula:

$$P = 2n \cdot r \sin\left(\frac{360^\circ}{2n}\right)$$

Tehani drew this diagram as part of her work as she developed this formula.

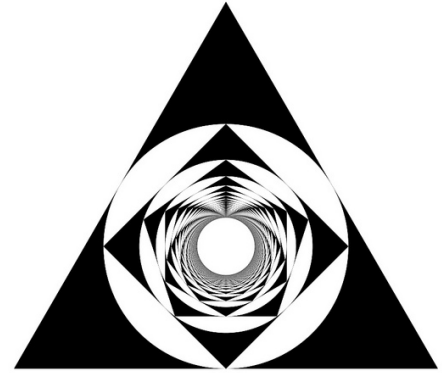

©2013 www.flickr.com/photos/andy-li

- Using Tehani's diagram, explain in detail how she arrived at her formula.

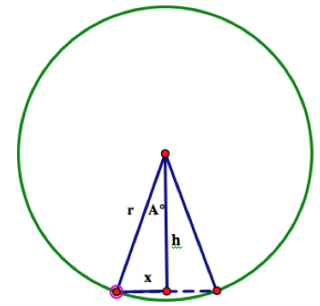

- Since  $n$  is the only thing that varies in this formula, Travis suggests that Tehani might rewrite her formula in the form  $P = 2r\left[n \cdot \sin\left(\frac{360^\circ}{2n}\right)\right]$ . Because the perimeter of an  $n$ -gon approximates the circumference of a circle when  $n$  is a large number of sides, Travis suggests they examine what happens to the  $n \cdot \sin\left(\frac{360^\circ}{2n}\right)$  portion of Tehani's formula as  $n$  gets larger and larger. Use a calculator or spreadsheet to complete the following table to see what happens.

$n$	$n \cdot \sin\left(\frac{360^\circ}{2n}\right)$
6	
12	
24	
48	
96	
100	
1,000	
10,000	

- Write a formula for the circumference of a circle based on Tehani's formula for the perimeter of an inscribed regular  $n$ -gon and what you have observed while generating this table.



**Part 2: From the area of a polygon to the area of a circle**

Approach #1

Tehani's formula for the area of a regular polygon with  $n$  sides inscribed in a circle of radius  $r$  is:

$$A = n \cdot r \sin\left(\frac{360^\circ}{2n}\right) \cdot r \cos\left(\frac{360^\circ}{2n}\right)$$

4. Explain in detail how Tehani arrived at this formula. You may refer to the diagram above.
5. Travis suggests that they might rewrite Tehani's formula in the form  $A = r^2 \cdot \left[ n \cdot \sin\left(\frac{360^\circ}{2n}\right) \cdot \cos\left(\frac{360^\circ}{2n}\right) \right]$  and then examine what happens to the last part of the formula as  $n$  gets larger and larger. Use a calculator or spreadsheet to complete the following table and see what happens.

$n$	$n \cdot \sin\left(\frac{360^\circ}{2n}\right) \cdot \cos\left(\frac{360^\circ}{2n}\right)$
6	
12	
24	
48	
96	
100	
1,000	
10,000	

6. Write a formula for the area of a circle based on Tehani's formula for the area of an inscribed regular  $n$ -gon and what you have observed while generating this table.



Approach #2

A circle can be decomposed into a set of thin, concentric rings, as shown on the left in the following diagram. If we unroll and stack these rings we can approximate a triangle as shown in the figure on the right.

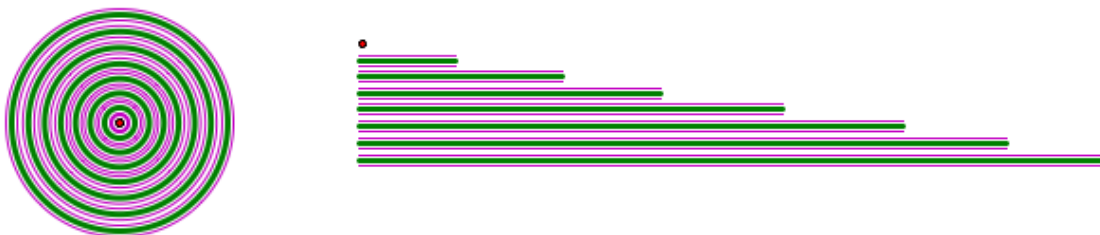

7. How might we describe the height of this “triangle” relative to the circle?
8. How might we describe the length of the base of this “triangle” relative to the circle?
9. As the rings get narrower and narrower the triangular shape gets closer and closer to an exact triangle with the same area as the circle. What would this diagram suggest for the formula of the area of a circle?

Approach #3

A circle can be decomposed into a set of congruent sectors, as shown on the left in the following diagram. We can rearrange these sectors to approximate a parallelogram as shown in the figure on the right.

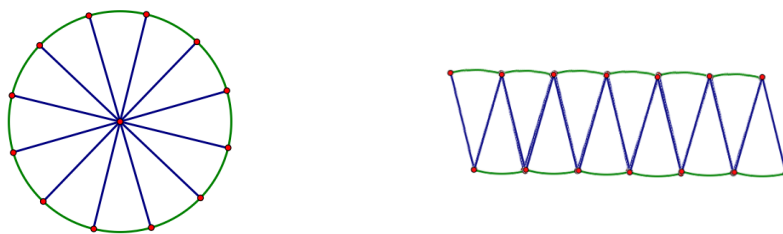

10. How might we describe the height of the “parallelogram” relative to the circle?
11. How might we describe the base of this “parallelogram” relative to the circle?
12. As we decompose the circle into more and more sectors the “parallelogram” shape gets closer and closer to an exact parallelogram with the same area as the circle. What would this diagram suggest for the formula for the area of a circle?





# 7.5 From Polygons to Circles – Teacher Notes

## *A Solidify Understanding Task*

---

**Purpose:** The purpose of this task is to extend the work with perimeter and area of regular polygons from the previous task. In this task students use informal limit arguments to argue that the perimeter and area of inscribed regular polygons converge upon the circumference and area of the circumscribed circle as the number of sides of the polygon increases.

### **Core Standards Focus:**

**G.GMD.1** Give an informal argument for the formulas for the circumference of a circle, area of a circle, volume of a cylinder, pyramid, and cone. Use dissection arguments, Cavalieri’s principle, and informal limit arguments.

### **Related Standards:**

#### **Launch (Whole Class):**

In the previous task students developed a strategy for finding the circumference and area of inscribed regular polygons. They may or may not have developed formulas for their strategy. If they did produce formulas for the circumference and area of regular inscribed polygons, compare them to the ones given in the task (see question 1 and question 4). If they did not develop such formulas, present Tehani’s formulas as given in the task. Give students time to examine these formulas and explain why they work before assigning them to work on the rest of the task.

#### **Explore (Small Group):**

Have students use the table features of a graphing calculator to complete the tables in questions 2 and 5. As  $n$ , the number of sides increases, students should notice that the factors listed in the tables converge on a number they should recognize as the value of  $\pi$ . Based on this observation, their formulas for circumference (question 3) and area (question 6) of a circle should be  $C = 2\pi r$  and  $A = \pi r^2$ , respectively. These formulas may not be new to students, but their derivations based on an informal understanding of limits and convergence will be new.

#### **Discuss (Whole Class):**

Summarize the formulas for circumference and area of a circle based on the tables generated in questions 2 and 5. Then have students present their explanations of the alternative proofs for the area of a circle given in approach 2 and approach 3.

### **Aligned Ready, Set, Go: Circles: a Geometric Perspective 7.5**



Name:

Ready, Set, Go!



©2013 www.flickr.com/photos/andy-li

Ready

Topic: Angles and Arcs of circles, ratios with similar shapes

Find the indicated values given the diagram and measurements provided below.

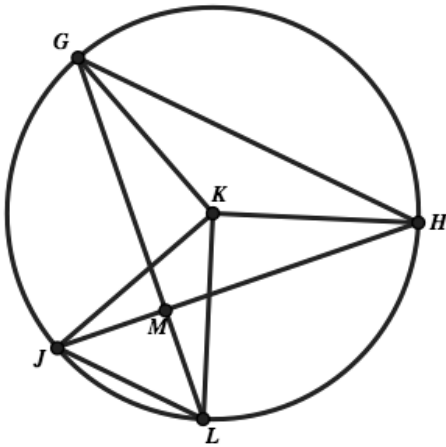

1. Given that  $m\angle LGH$  and  $m\angle GHJ$  are both  $45^\circ$   
 What other measurement of angles or arcs do you know?  
 List them below (try to find six)

2. Given that  $\triangle GKH$  has two sides that are radii of the circle.  
 What type of triangle is  $\triangle GKH$ ?  
 Are there any other triangles of this type in the diagram? If so, name them.

3. Given that the  $m\widehat{GH}$  is  $113.2^\circ$   
 What is  $m\widehat{JL}$ ? (Look back at problems 1 and 2)

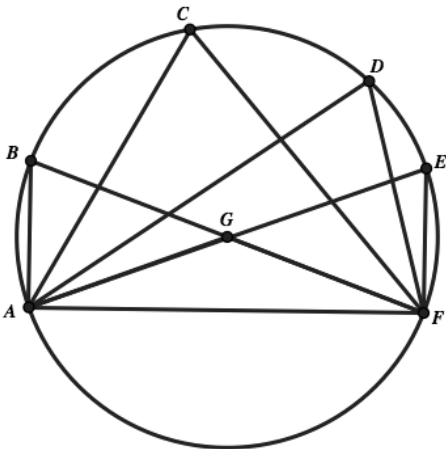

4. Given  $\odot G$ , which angles would have the same measure?  
 List them all below and say how you know they are equal.

5. There are several triangles in the circle. List the triangles that are inscribed triangles.

Also, list any other triangles and classify as many of the triangles as you can.

6. Given that  $m\angle GFE = 70^\circ$  find all possible angle and arc measurements that you can.



Given the similar shapes below provide the desired missing sides or proportions.

7.

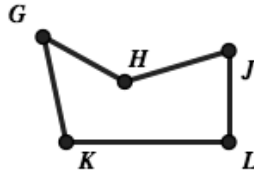
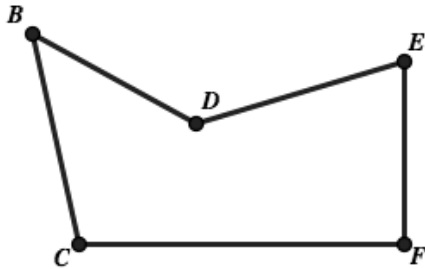

a.  $\frac{BD}{BC} = \frac{?}{?}$

Fill in the proportion and state how you know it is correct.

b.  $\frac{JL}{EF} = \frac{KL}{?}$

Fill in the proportion and state how you know it is correct.

c. If possible, fill in the missing proportions so they are true statements. If not possible say why not.

i)  $\frac{DE}{HJ} = \frac{?}{?}$

ii)  $\frac{CF}{KL} = \frac{?}{?}$

iii)  $\frac{GH}{?} = \frac{BD}{?}$

iv)  $\frac{BC}{?} = \frac{GK}{?}$

v)  $\frac{HJ}{?} = \frac{?}{BC}$

**Set**

Topic: Connecting polygons with circles

8. Below you are given a circle and also several squares that are constructed so that their sides are equal to the radius of the circle. Use these squares and circle to estimate how many squares it takes to fill in the area of the circle. State what you notice. (You are welcome to use tracing paper or create cut outs.)

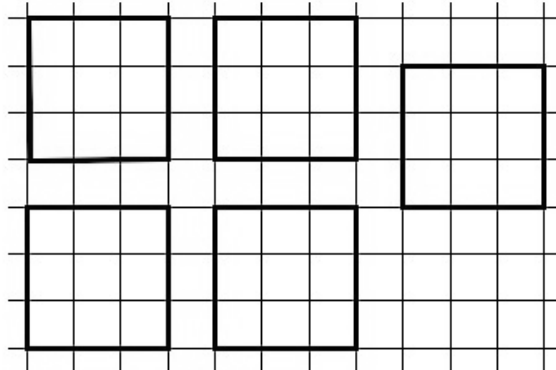
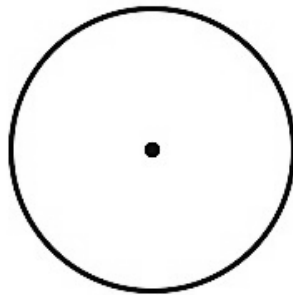

9. Which of the polygons below would have an area and perimeter closest to the circle it is inscribed within? Why?

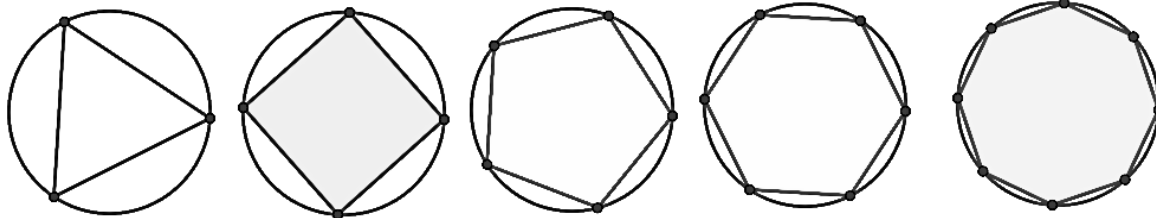

## Circles: a Geometric Perspective | 7.5

10. Given that the radius of the circles in **previous problem** is 10 feet. Find the area of each of the regular polygons and list them in the table below along with the measure of one angle for each polygon and the side length of each polygon. (A couple are filled in for you.)

Shape	One interior angle	Length of one side	Area of figure
Triangle	60°		
Square		$10\sqrt{2} = 14.14$	
Pentagon			
Hexagon			
Octagon			
Circle			

11. Show and explain how a circle can be cut into sectors and reconfigured to appear approximately as a polygon that could have its area calculated using a standard formula.

12. Show and explain how a circle can be broken into several rings or interior circles that can be rearranged to appear approximately as a polygon that could have its area calculated using a standard formula.

## Go

Topic: Finding arc length as a distance.

*Just as a circle can be broken into 360 sectors as a means finding the area of any size sector. Similarly the circumference of a circle can be broken into 360 equivalent pieces as a means for finding the distance actually traveled along any arc of the circle.*

The circumference of the circle is  $6\pi$  inches.

So, a sector of one degree would have length of  $\frac{6\pi}{360}$  inches.

And so the area of the sector with a central angle of  $80^\circ$

Would be  $(80)\frac{6\pi}{360}$  which simplifies to be  $\frac{4\pi}{3}$  inches or approximately 4.19 inches.

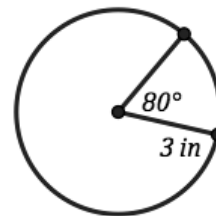

Look closely at the example on the previous page and then use this strategy for finding the arc length (actual distance traveled along the path of the arc) in each of the problems provided below.

13.

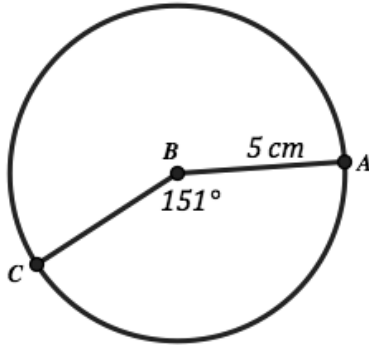

14.

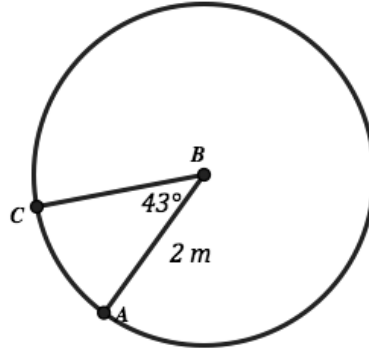

15.

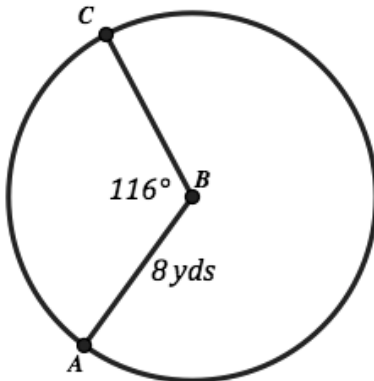

16.

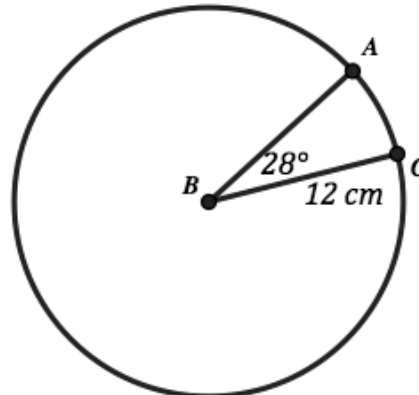

Need Assistance? Check out these additional resources:  
<http://www.mathopenref.com/arclength.html>  
<http://plus.maths.org/content/what-area-circle>



# 7.6 Circular Reasoning

## *A Practice Understanding Task*

The following problems will draw upon your knowledge of similarity, circle relationships and trigonometry.



©2013 www.flickr.com/photos/koordy

In the following diagram the radius of  $\odot D$  is 5 cm and  $F$  is the midpoint of  $\overline{AE}$ . The measures of arc  $EB$  and arc  $BC$  are given in the diagram. Find the measures of all other unmarked angles, arcs and segments.

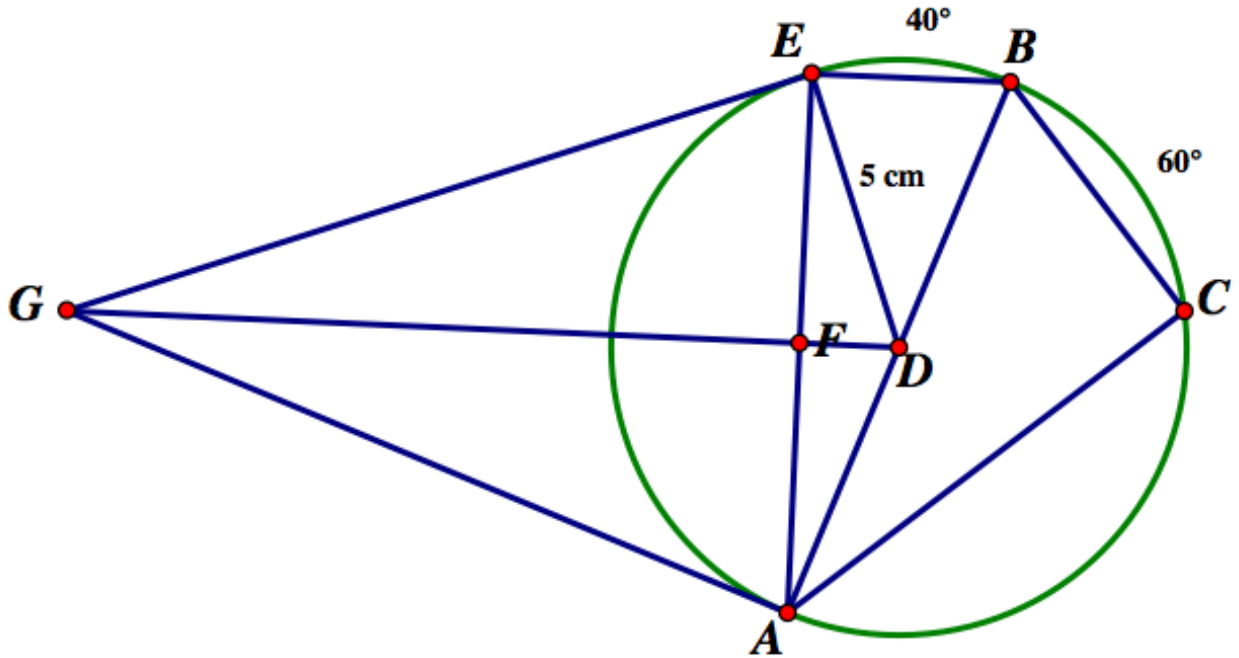

In the diagram below  $\triangle ABC$  is equilateral. All circles are tangent to each other and to the sides of the equilateral triangle. The radius of the three smaller circles,  $\odot P$ ,  $\odot Q$  and  $\odot R$ , is 4 cm. The radius of  $\odot O$  is not given. Find the circumference and area of each circle and the length of the sides of the equilateral triangle.

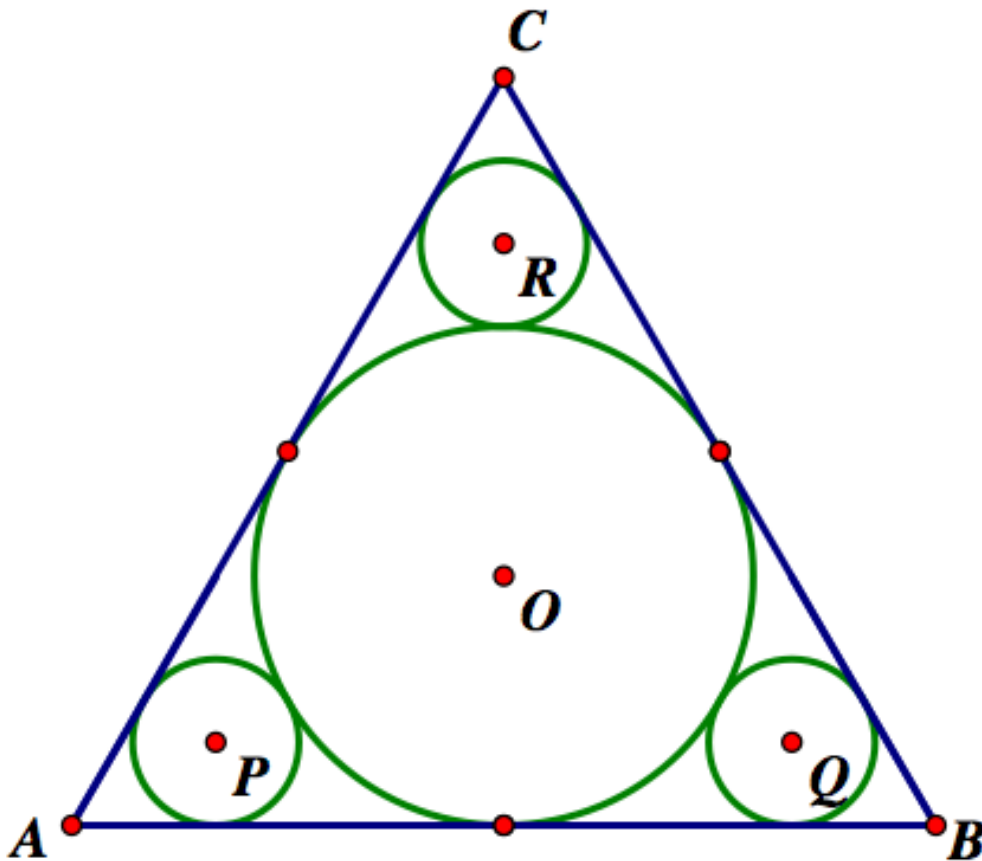

## 7.6 Circular Reasoning – Teacher Notes

### *A Practice Understanding Task*

---

**Purpose:** The purpose of this task is to review and practice theorems and formulas associated with circles. Students will also draw upon ideas of similarity as well as right triangle trigonometry relationships to find the lengths of line segments.  $30^\circ$ - $60^\circ$ - $90^\circ$  triangles appear frequently in this task, so there is an opportunity to emphasize the relationships between the sides and how one can find the exact values of the lengths of the sides in this special right triangle.

#### **Core Standards Focus:**

**G.C.2** Identify and describe relationships among inscribed angles, radii, and chords. Include the relationship between central, inscribed, and circumscribed angles; inscribed angles on a diameter are right angles; the radius of a circle is perpendicular to the tangent where the radius intersects the circle.

#### **Related Standards: G.C.3**

#### **Launch (Whole Class):**

If students are not already familiar with the relationships between the sides of a  $30^\circ$ - $60^\circ$ - $90^\circ$  triangle, introduce this topic by drawing an equilateral triangle and decomposing it into two  $30^\circ$ - $60^\circ$ - $90^\circ$  triangles by drawing an altitude of the equilateral triangle. Note that the altitude intersects the opposite side at its midpoint, and therefore, the short leg of a  $30^\circ$ - $60^\circ$ - $90^\circ$  triangle is half the length of the hypotenuse. Use the Pythagorean theorem to show that the length of the long leg of a  $30^\circ$ - $60^\circ$ - $90^\circ$  triangle is  $\sqrt{3}$  times the length of the short leg. Suggest that students look for  $30^\circ$ - $60^\circ$ - $90^\circ$  triangles in the given diagrams, and that they label the lengths of sides of these triangles with exact values. They should also look for other right triangles in the figures whose side lengths can be found using trigonometry.

#### **Explore (Small Group):**

Encourage students to begin their work on figure #1 by finding the measures of all of the missing angles before working on finding the lengths of line segments. This will identify the right triangles in the diagram.

#### Hints for figure #1

Students will need to draw upon such theorems as:

- Angles inscribed in a semicircle are right angles.
- The perpendicular bisector of a chord passes through the center of the circle.
- All radii of a circle are congruent.
- The measure of an inscribed angle is half the measure of the intercepted arc.

© 2013 Mathematics Vision Project | MVP

In partnership with the Utah State Office of Education

Licensed under the Creative Commons Attribution-NonCommercial-ShareAlike 3.0 Unported license.





- A circumscribed angle and the central angle that intercepts the same arc are supplementary. Students will also need to use trigonometric relationships to find missing sides of right triangles.

Let students surface as many ideas as they can about figure #2 before giving them any hints. At some point you may want to move to a whole class discussion to make a list of what students know with certainty about the diagram, what they assume might be true but aren't sure how to convince themselves that their assumptions are correct, and what else they still need to figure out. Move back and forth between discussing hints as a whole class and allowing students to continue exploring figure #2 in small groups using the hints.

### Hints for figure #2

- Since this is an equilateral triangle, the altitudes, medians, angle bisectors and perpendicular bisectors of the sides are all the same lines. Therefore, the center of the inscribed circle  $O$  lies on the angle bisectors (recall that the incenter of a triangle is the point of concurrency of the angle bisectors) as well as on the perpendicular bisectors of the sides. Therefore, circle  $O$  is tangent to the sides of the equilateral triangle at the midpoints of the sides.
- It is helpful to draw some auxiliary line segments in this diagram. For example, if we name the midpoint of segment  $AB$  as point  $M$ , then adding segments  $OM$  and  $OA$  forms a  $30^\circ$ - $60^\circ$ - $90^\circ$  right triangle.
- We can convince ourselves that point  $P$  lies on segment  $OA$  by drawing a line through the point of tangency of circles  $O$  and  $P$  parallel to side  $BC$ . This parallel line forms a smaller equilateral triangle with circle  $P$  inscribed. The center of circle  $P$  lies on the same angle bisector as the center of circle  $O$ .
- There is a dilation, centered at  $A$ , that will carry point  $P$  onto point  $O$  (and therefore, carry the smaller equilateral triangle described in the previous paragraph onto the larger equilateral triangle). Can we find the scale factor of this dilation?
- The adjacent diagram illustrates that the center of the circle inscribed in an equilateral triangle is  $2/3$  of the distance along the altitude from each vertex of the triangle. For example, point  $D$ , the center of the inscribed circle in the diagram is  $2/3$  of distance  $AF$  from vertex  $A$ . This can be shown by drawing radius  $DE$  to the midpoint of side  $AG$ , and also drawing segment  $DG$  to form three congruent  $30^\circ$ - $60^\circ$ - $90^\circ$  triangles, as shown. If the figure is folded along line  $DG$ , segment  $ED$ —the short leg of right triangle  $DEG$ —gets superimposed onto segment  $DF$ . If the figure is folded along line  $ED$ , segment  $GD$ —the hypotenuse of right triangle  $DEG$ —gets superimposed onto segment  $AD$ . Therefore, the ratio of  $AD$  to  $DF$  is  $2:1$ , the same as the ratio of the length of the hypotenuse to the length of the short leg of a  $30^\circ$ - $60^\circ$ - $90^\circ$  triangle. Therefore, distance  $AD$  is  $2/3$  of the length of the altitude  $AF$ .

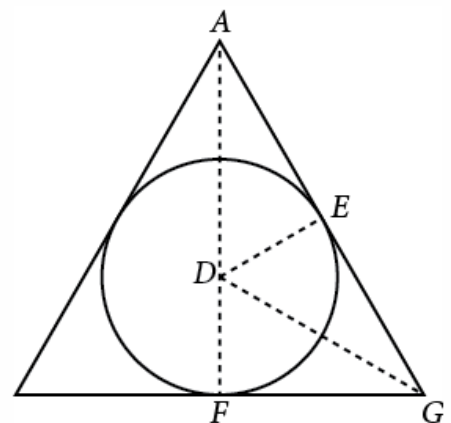

**Discuss (Whole Class):**

Figure #1 should not need any whole group discussion. Instead, give individuals and small groups hints to support their progress on figure #1.

Move back and forth between small group exploration and whole group discussion on figure #2. As suggested in the explore, an initial whole group discussion might focus on making a list of what students know with certainty about the diagram, what they assume might be true but aren't sure how to convince themselves that their assumptions are correct, and what else they still need to figure out. Give students a hint, and then let them return to their exploration. One important hint comes from adding an auxiliary line parallel to one side of the equilateral triangle through the point of tangency of a little circle and the big circle. This forms a smaller equilateral triangle with its inscribed circle—a scaled down version of the original problem. Working on the scaled down problem allows students to focus on the single inscribed circle of an equilateral triangle, without the three additional circles getting in the way of their thinking. Suggest that they look for ways to decompose the equilateral triangle into  $30^\circ$ - $60^\circ$ - $90^\circ$  triangles.

**Aligned Ready, Set, Go: Circles: a Geometric Perspective 7.6**

Name:

## Circles: a Geometric Perspective | 7.6

## Ready, Set, Go!



©2013 www.flickr.com/photos/kdordy

## Ready

Topic: Measurement conversion and scaling

Many times items we are interested in measuring or keeping track of in some way are tracked in a unit of measure that we need to change.

**Below you will find several measurements, convert them all to the units of feet.**

(1 foot = 12 inches, 1 yard = 3 feet, 1 mile = 5280 feet)

- |              |              |               |
|--------------|--------------|---------------|
| 1. 50 inches | 2. 2.5 yards | 3. 133 inches |
| 4. 7 yards   | 5. 2 miles   | 6. 8 inches   |

The equation  $C = \frac{5}{9}(F - 32)$  will convert temperatures measured in Fahrenheit to the unit of Celsius measurement.

**Use this equation to convert the given temperatures.**

- |          |          |          |
|----------|----------|----------|
| 7. 50°F  | 8. 98°F  | 9. 32°F  |
| 10. 20°C | 11. 85°C | 12. 42°C |

## Set

Topic: Arc Length, Arc Measure, Central and Inscribed Angles

**Use the figure below and the givens to find all angle measures and arc measures possible.**

13.

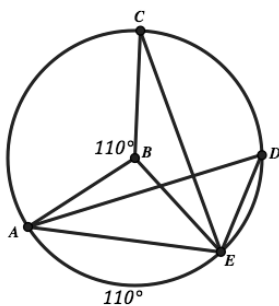
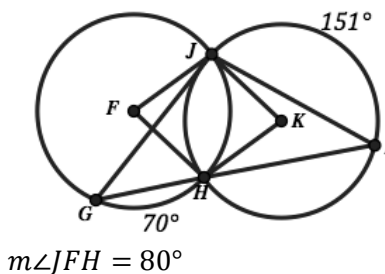
14.  $\odot F \cong \odot K$  and  $\angle JFH \cong \angle JKH$ 

© 2013 MATHEMATICS VISION PROJECT | MVP

In partnership with the Utah State Office of Education

Licensed under the Creative Commons Attribution-NonCommercial-ShareAlike 3.0 Unported license



15. In the figure below. Given that  $\Delta JKL$  is an equilateral triangle. List all of the angle and arc measurements that you will know for sure as a result of this given item.

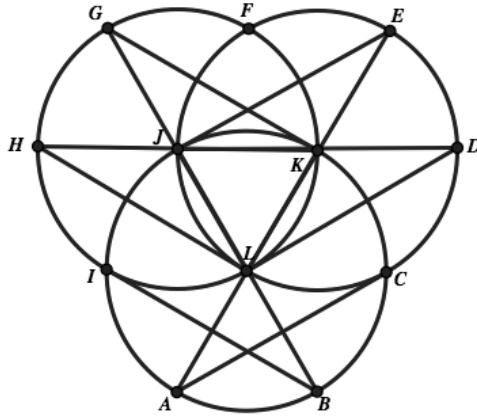

16. In the figure above. Given that  $\Delta JKL$  is an equilateral triangle and each side is 5 units of length. List all of the segment and arc length measurements that you will know for sure as a result of this given information.

**Go**

Topic: Area and Distance for composed figures

**Find the area and perimeter for each of the figures below.**

17.

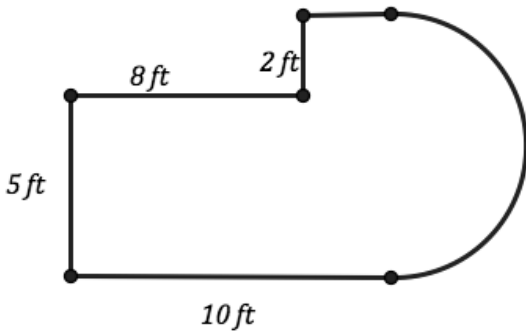

18.

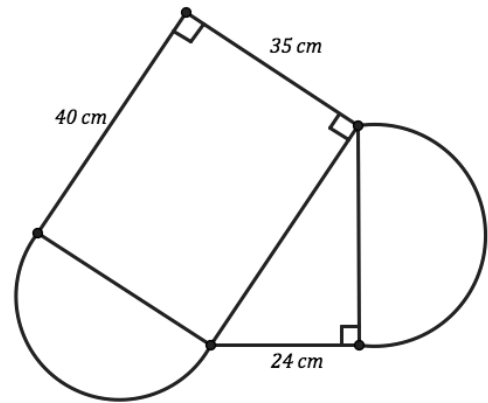

## 7.7 Pied

### *A Develop Understanding Task*

Students have planned several activities to celebrate Pi Day at their school. In addition to pie eating contests and “pie-ing” their favorite teachers, the Math Club plans to make money by selling slices of pie during lunch hour. Each member of the club has contributed a couple of homemade pies for the sale. Unfortunately, the members chose a variety of sizes and shapes of pans to bake their pies in. Some students used 9-inch round pans for their pies, others used 8-inch round pans, a few used 8-by-8 inch square pans, and one student used a 9-by-13 inch cake pan for his pie. Now the club members have the dilemma of how to slice the pies so each slice is about the same amount, since they plan to charge the same amount for each slice of pie regardless of the pan it came from.



© 2013 www.flickr.com/photos/slemmon

After much debate, the club members have decided to slice the 8-inch round pies into 5 equal slices (or *sectors* as the math geeks call them), the 9-inch round pies into 6 equal slices, the 8-by-8 inch pies into 2-by-4 inch rectangles, and the 9-by-13 inch pie into 3-by-3  $\frac{1}{4}$  inch rectangles.

Although the pieces look like they are all about the same size, some students think there might be a price advantage in buying one type of slice over another.

1. Which slice of pie is the largest and which is the smallest? How did you decide?

Unfortunately, not everyone in the math club is good at eye-balling equal size *sectors* when cutting round pies. Therefore, one of the students is assigned to be in charge of “quality control”. He is given a protractor and is told to reject any slices of pie that are more or less than  $4^\circ$  from the exact angle measurement.

2. Using this criteria, what is the smallest and largest amount of pie you might get in a slice of pie taken from the 8-inch pan?
3. Using this criteria, what is the smallest and largest amount of pie you might get in a slice of pie taken from the 9-inch pan?



The student in charge of quality control finds it is too difficult to measure the angle of a sector of pie in degrees, and suggest that they cut a piece of string that could be used to measure around the outer edge of the pie to let the servers know where to make the next cut.

4. How long should this string be to measure the arc of a slice of pie for the 8-inch round pies?
5. How long should this string be to measure the arc of a slice of pie for the 9-inch round pies?

Wendell really likes pie and has offered to pay double the price for a slice of pie that is guaranteed to contain at least  $15 \text{ in}^2$  of pie.

6. What is the degree measure of the smallest sector of the 8-inch round pie that will satisfy Wendell's cravings?
7. How long should the string be that will measure the outer arc of this sector?
8. What is the degree measure of the smallest sector of the 9-inch round pie that will satisfy Wendell's cravings?
9. How long should the string be that will measure the outer arc of this sector?
10. A sector of the 9-inch round pie measures  $n^\circ$ . What is its area? What is its arc length?



# 7.7 Pied – Teacher Notes

## *A Develop Understanding Task*

---

**Purpose:** In this task students use proportional reasoning to calculate arc length and the area of a sector relative to the circumference and area of the circle. The work of this task lays a foundation for the work of the next task in which proportionality relationships between arc length and radius are used to define radian measurement.

### **Core Standards Focus:**

**G.C.5** Derive using similarity the fact that the length of the arc intercepted by an angle is proportional to the radius, and define the radian measure of the angle as the constant of proportionality; derive the formula for the area of a sector.

**Mathematics I Note for G.C.5:** *Emphasize the similarity of all circles. Note that by similarity of sectors with the same central angle, arc lengths are proportional to the radius. Use this as a basis for introducing radian as a unit of measure. It is not intended that it be applied to the development of circular trigonometry in this course.*

### **Related Standards:**

#### **Launch (Whole Class):**

Read through the story context of this task with your students to surface the key ideas of the mathematics of this task—which is *to find ways to calculate portions of the area of a circle (the portions that we refer to as sectors), and portions of the circumference*. Once students are aware of the purpose of the task, set them to work on the questions that the members of the math club are trying to answer.

#### **Explore (Small Group):**

Watch for students who recognize that they can calculate arc lengths and areas of sectors by multiplying the circumference or area of the circle by a fraction. Initially these fractions are given (e.g.,  $\frac{1}{5}$  of the pie). As the task progresses, students will have to determine these fractions by considering the number of degrees in the portion relative to the number of degrees in the whole circle,  $360^\circ$ . Listen for students making sense of the situation by saying things such as, “ $4^\circ$  more than  $\frac{1}{5}$  of a circle is  $76^\circ$  since  $\frac{1}{5}$  of a circle is  $72^\circ$ . We need to find  $\frac{76}{360}$  of the area of a pie with a diameter of 8 inches.”

#### **Discuss (Whole Class):**

It is not necessary to discuss all of the questions in the task, but it may be helpful to discuss one question of each type, such as question 3 (area of a sector), question 5 (arc length), and question 9 (arc length for a given area of a sector).



Discuss question 10 for a 9-inch pie, and then generalize for a pie whose radius is  $r$  inches. Students should be able to summarize the work of this task with formulas for the arc length and area of a sector for a circle of radius  $r$  and a central angle of  $n^\circ$  as follows:

$$\text{Arc length} = \frac{n}{360} \cdot 2\pi r$$

$$\text{Area of sector} = \frac{n}{360} \cdot \pi r^2$$

**Aligned Ready, Set, Go: Circles: a Geometric Perspective 7.7**





Name:

## Circles: a Geometric Perspective | 7.7

## Ready, Set, Go!



## Ready

©2013 www.flickr.com/photos/slemmon

Topic: Circumference, ratios

1. There are four circles below each with a different radius. Determine the circumference and area of each and look for any patterns. What do you notice?

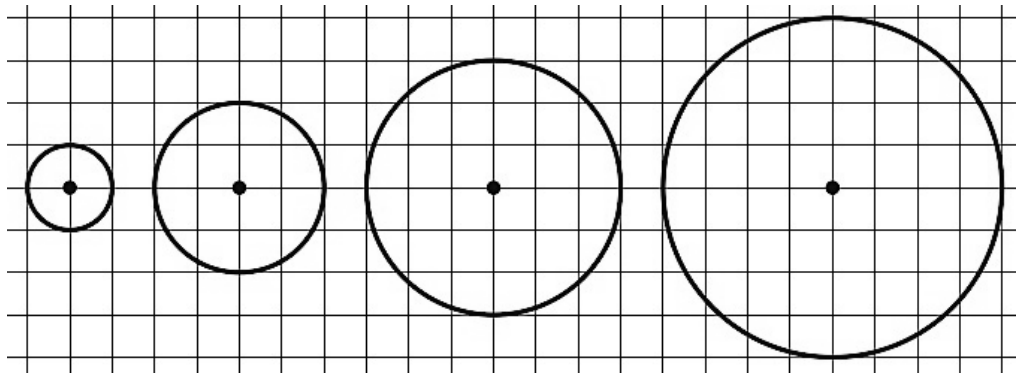

	Radius = 1	Radius = 2	Radius = 3	Radius = 4
Circumference				
Area				

*A ratio is a comparison between two quantities. Trigonometric ratios of sine, cosine and tangent are ratios between sides in a right triangle. We can make ratios between many different quantities.*

**Write ratios for the indicated quantities below.**

- The ratio of boys to girls in our math class.
- The ratio of girls to boys in your family.
- The ratio bathrooms to bedrooms in your house.
- The ratio of televisions to people that live in your house.
- The ratio of people in your house to cell phones in your house.

© 2013 MATHEMATICS VISION PROJECT | MVP

In partnership with the Utah State Office of Education

Licensed under the Creative Commons Attribution-NonCommercial-ShareAlike 3.0 Unported license



**Set**

Topic: Fluency with area and circumference and sectors of circles.

Use the given information to determine the desired item.

7. The area of the circle is  $25\pi$  cm<sup>2</sup>.  
What is the circumference of the circle?

8. The circumference of the circle is  $10\pi$  feet.  
What is the area of the circle?

9. The area of the small sector is  $20\pi$  ft<sup>2</sup>.  
What is the radius of the circle?

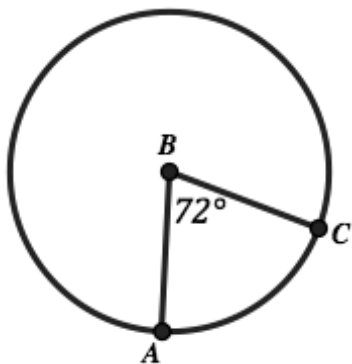

10. The arc length of arc AC measures  $16\pi$  cm.  
What is the area of the circle?

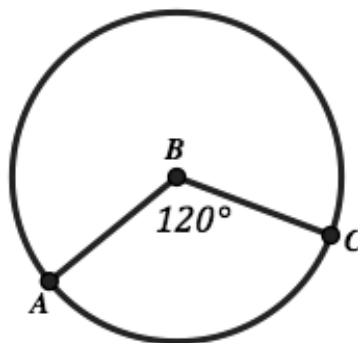

11. The arc length of arc DF measures 30 m.  
What is the area of the circle?

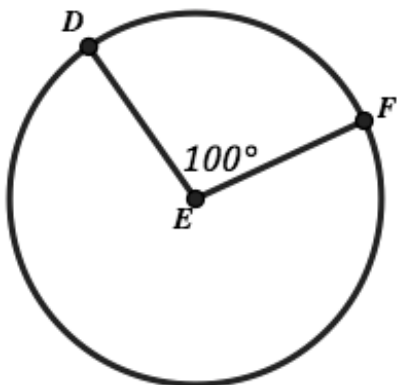

12. The area of the small sector is  $\pi$  in<sup>2</sup>.  
What is the circumference of the circle?

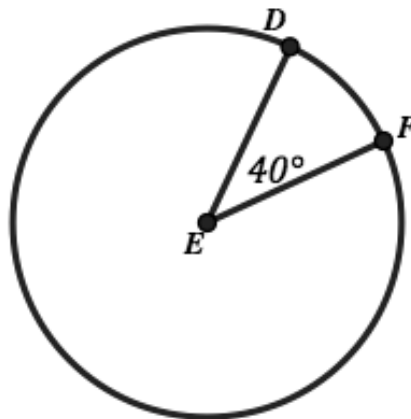

**Go**

Topic: Finding area and decomposing area.

Find the area of the darkest shaded region in each figure below.

13.

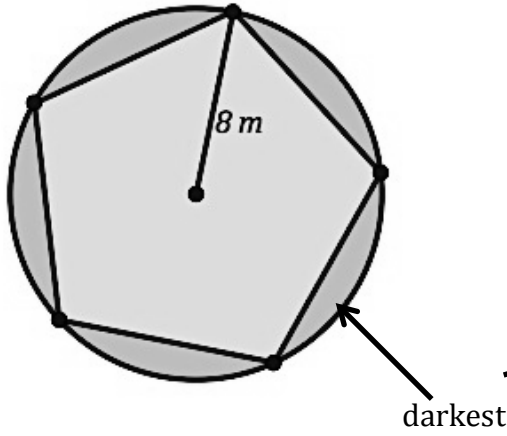

14.

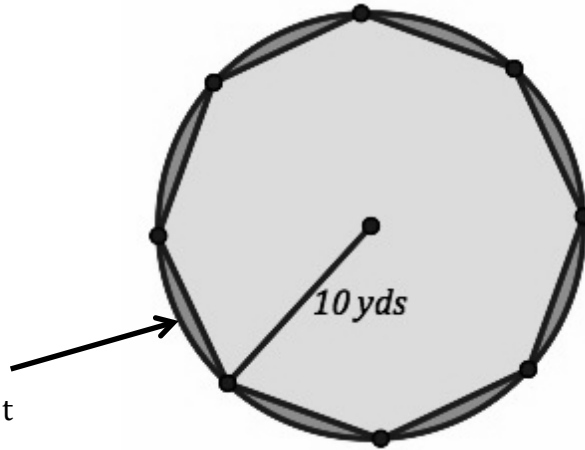

15.

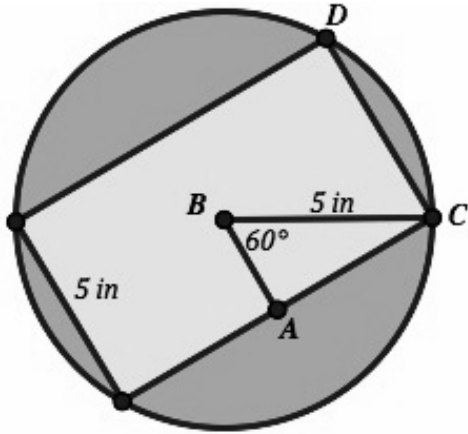

16.

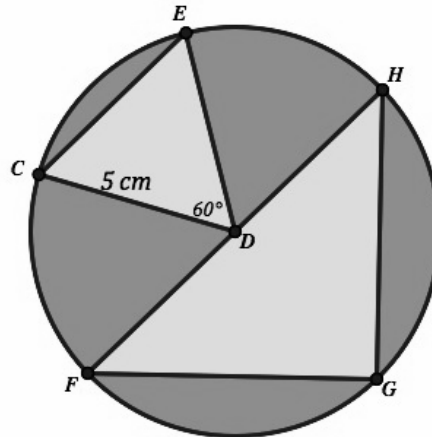

## 7.8 Madison's Round Garden

### *A Practice and Develop Understanding Task*

Last year Madison won the city's "Most Outstanding Garden" Award for her square garden. This year she plans to top that with her design for a beautiful round garden.

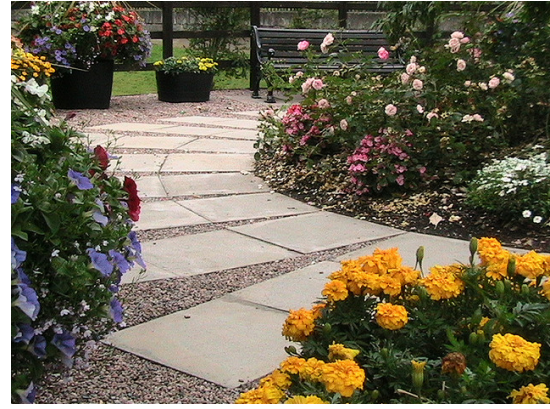

© 2013 www.flickr.com/photos/missfitzphotos

Madison's design starts with a sprinkler in the center, and concentric rings of colorful flowers surrounding the central sprinkler. Pavers will create both circular pathways and pathways that look like spokes on a wheel between the flowers. The sprinkler can be adjusted so it waters just the inner circle of flowers, or it can be adjusted so it waters the entire round garden. Consequently, flowers that need to be watered more frequently will be placed near the center of the garden, and those that need the least amount of water will be placed farthest from the center. The sectors of the garden will not all be the same size, since they need to accommodate different types of plants.

Here is Madison's design for her garden. The number of degrees in each sector has been marked.

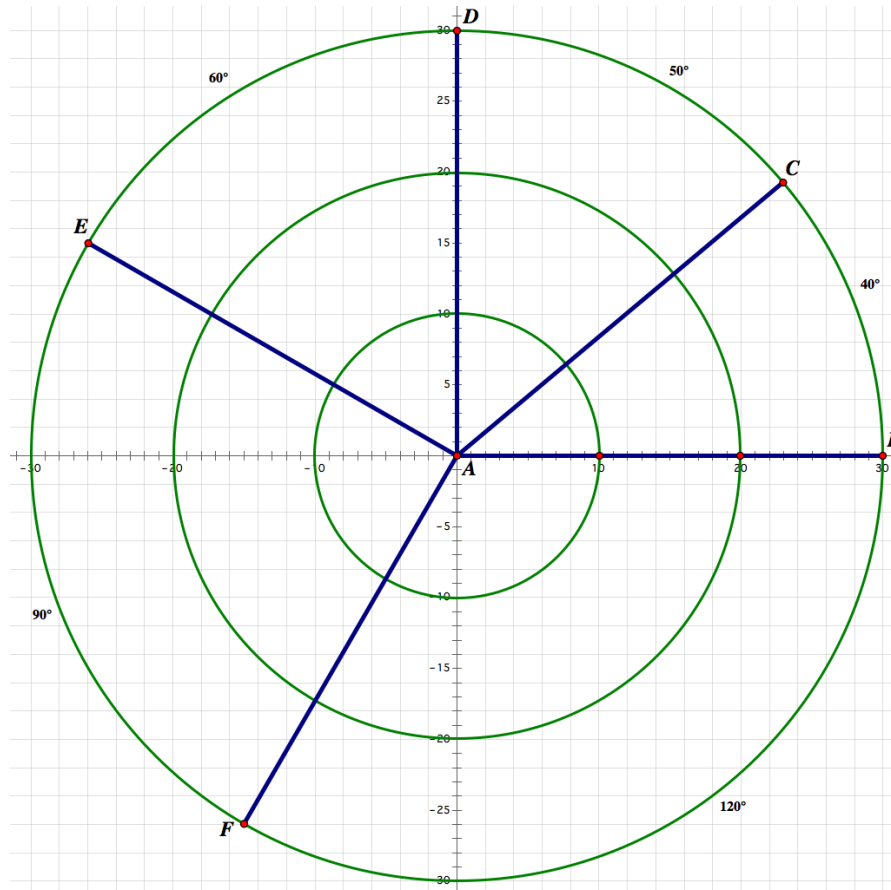

© 2013 Mathematics Vision Project | MVP

In partnership with the Utah State Office of Education

Licensed under the Creative Commons Attribution-NonCommercial-ShareAlike 3.0 Unported license.



- Madison has only marked the degree measure on the arcs of the outermost ring of the garden. Determine the angle measure for the arcs on the inner and middle rings of the garden.
- Madison needs to order pavers for the garden. She plans to vary the size and colors of the pavers in different parts of the garden. Consequently, she needs to know the lengths of different portions of the paths. Help her complete this table by calculating the missing arc lengths.

	Distance from Center	Arc Length				
		40° Sector	50° Sector	60° Sector	90° Sector	120° Sector
Inner Circle of Pavers	10 feet					
Middle Circle of Pavers	20 feet					
Outer Circle of Pavers	30 feet					

- As Madison filled out the table she began to notice some interesting things. What did you notice?
- One thing Madison noticed involved the ratio of the arc length to the radius of the circle. Complete this version of the table and state what you think Madison noticed.

	Distance from Center	Arc length / Radius				
		40° Sector	50° Sector	60° Sector	90° Sector	120° Sector
Inner Circle of Pavers	10 feet					
Middle Circle of Pavers	20 feet					
Outer Circle of Pavers	30 feet					



As Madison examined these numbers, she realized that they behave the same way that degree measurements behave—all arcs in the same sector have the same degree measurement, and all arcs in the same sector have the same value for the ratio of arc length to radius. This made her wonder if these new numbers could be used as a way of measuring angles just as degrees are used.

Later that evening Madison shared her discovery with her older sister Katelyn who is taking calculus at a local university. Katelyn told Madison that her new numbers for measuring angles in terms of the ratio of the arc length to the radius are known as *radians* and that they make the rules of calculus much easier than if angles are measured in degrees.

Madison learned so much from examining the arc length of the sectors of her garden that she decides to examine the areas of the sectors also.

5. Complete this table for Madison by calculating the areas of the sectors for the different rings of the garden.

	Distance from Center	Area of Sector				
		40° Sector	50° Sector	60° Sector	90° Sector	120° Sector
Inner Circle of Pavers	10 feet					
Middle Circle of Pavers	20 feet					
Outer Circle of Pavers	30 feet					

6. Do you notice anything interesting in this table?



# 7.8 Madison's Round Garden – Teacher Notes

## *A Practice and Develop Understanding Task*

---

**Purpose:** Using the formulas for arc length and area of a sector developed in the previous task, in this task students use proportional reasoning to calculate the ratio of arc length to radius to define a constant of proportionality for any given angle intercepting arcs of concentric circles. This constant provides an alternative way of measuring the angle: radians.

### **Core Standards Focus:**

**G.C.5** Derive using similarity the fact that the length of the arc intercepted by an angle is proportional to the radius, and define the radian measure of the angle as the constant of proportionality; derive the formula for the area of a sector.

**Mathematics I Note for G.C.5:** *Emphasize the similarity of all circles. Note that by similarity of sectors with the same central angle, arc lengths are proportional to the radius. Use this as a basis for introducing radian as a unit of measure. It is not intended that it be applied to the development of circular trigonometry in this course.*

### **Related Standards:**

#### **Launch (Whole Class):**

Read through the story context with students, and then ask them to complete question 1. This is not intended to be a trick question—although it is an easy one to respond to. The goal of this question is to remind students that the measure of an angle remains the same no matter how far from the vertex point we measure it. This idea is important in supporting Madison's observation and claim later in the task. Point out that the work of filling out the tables for arc length and areas of sectors is the same as the work students did in the previous task, *Pied*. Students may use the formulas or strategies they developed in that task to complete these tables.

#### **Explore (Small Group):**

While student may use technology to compute the values in the tables, encourage them to record the notation that describes what they are calculating so patterns become more evident. For example, when calculating the ratio of the arc length to radius, the radius of the circle divides out.

#### **Discuss (Whole Class):**

The discussion should focus on why the ratio of arc length to radius is always the same value for the same central angle,  $n^\circ$ , and why Madison thinks these values could be used as reasonable angle measurements. To see why the ratio is constant, examine the notation for a calculating the ratio in general:



$$\frac{\text{arc length}}{\text{radius}} = \frac{\frac{n^\circ}{360} \cdot 2\pi r}{r} = \frac{2\pi}{360} \cdot n^\circ.$$

It becomes apparent that this ratio is just a constant multiple of the degree measurement,  $n^\circ$ .

Have students label each arc in each sector with these ratio values. As in question 1, each arc within a sector gets labeled with the same number. These ratio values behave in the same way as degree angle measurements. Help students articulate the key idea to emerge from this task: Multiplying an angle measured in degrees by  $\frac{2\pi}{360}$ , or  $\frac{\pi}{180}$ , converts the angle measurement into this new *radian* measurement for the angle.

### **Aligned Ready, Set, Go: Circles: a Geometric Perspective 7.8**





Name: \_\_\_\_\_

# Circles: a Geometric Perspective | 7.8

## Ready, Set, Go!

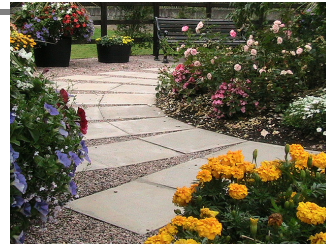

©2013 www.flickr.com/photos/missfitzphotos

### Ready

Topic: Finding volume and surface area

Find the volume and surface area for the 3-dimensional shapes below.

1.

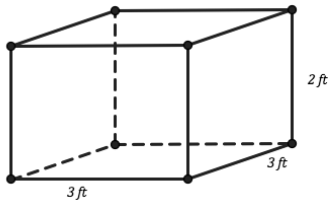

- a. Volume =
- b. Surface Area =

2.

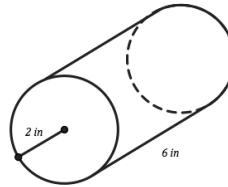

- a. Volume =
- b. Surface Area =

3.

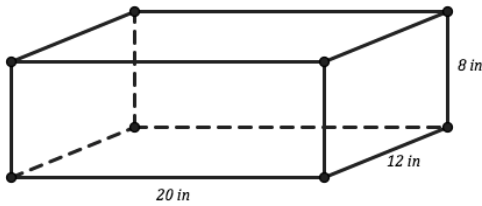

- a. Volume =
- b. Surface Area =

### Set

Topic: Radians

4. Below are circles of radius 1, 2, 3, and 4 units. Each of them has a diameter drawn that cuts them into two equal sectors. Find the arc length of one half of each of these circles. Then find the radian measure of the arc length for each one.

Find the length of the arcs on this half.

Radius	Length of arc for half the circle	Radian measure of half the circle
1		
2		
3		
4		

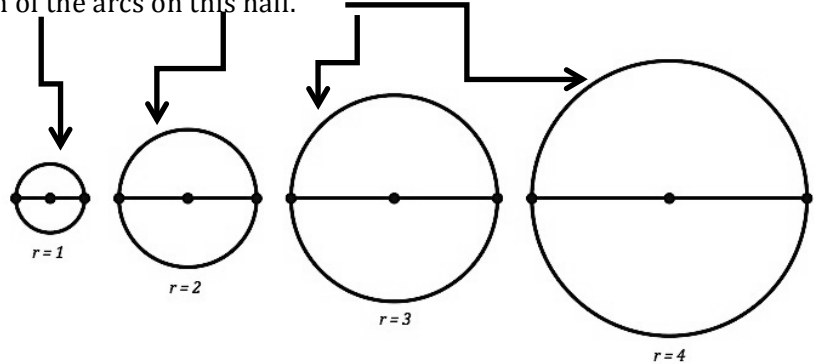

## Circles: a Geometric Perspective | 7.8

5. There are three circles below each with a different radius. The same size angle  $45^\circ$  has been used to create a sector in each circle. Fill in the table with the length of the arc measure for the sector, the radian measure and the area of the sector.

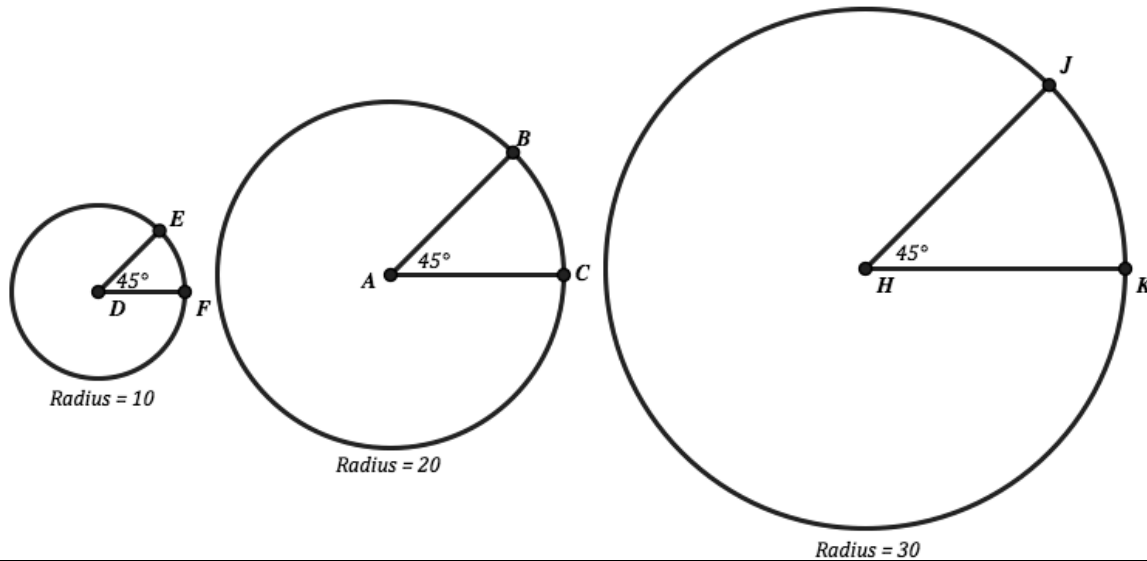

Radius	Length of arc	Radians	Area of sector
10			
20			
30			

6. Use the three circles in problem 5 to find the following ratios.

a.  $\widehat{EF}$  to  $\widehat{BC}$

b.  $\widehat{BC}$  to  $\widehat{JK}$

c.  $\widehat{EF}$  to  $\widehat{JK}$

d. What do you notice about the ratios between the arc lengths?

7. Considering  $\widehat{EF}$  above in problem 5. (a) How many copies of this arc would be needed to be equal to the length of the entire circumference of circle D? (b) Would this be true for the other arcs and circles in the problem above? Why?



**Go**

Topic: Same angle different size sectors and arcs, accompanying ratios

Consider the sectors and arc lengths in the two circles below to answer the questions.

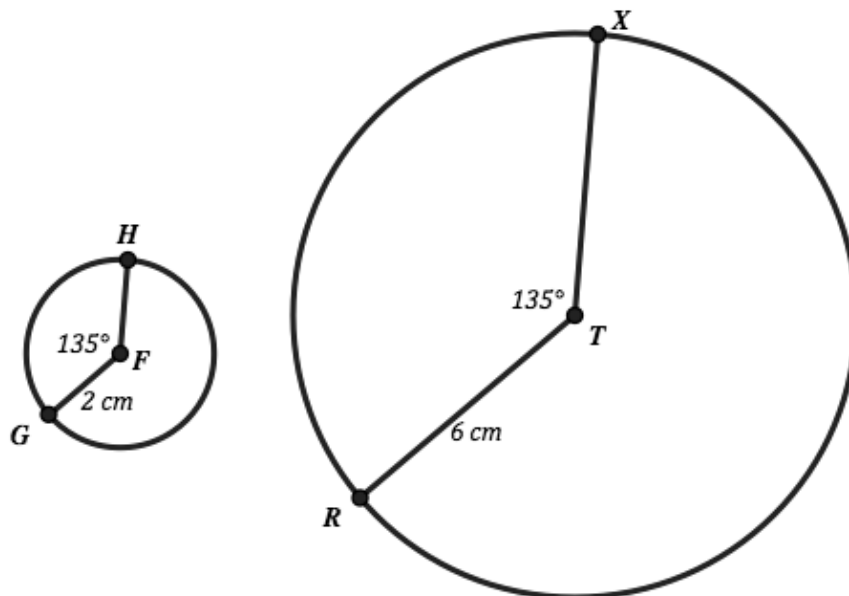

8. Find the arc length of arc  $GH$ .
9. Find the arc length of arc  $RX$ .
10. Find the area of the small sector in circle  $F$ .
11. Find the area of the small sector in circle  $T$ .
12. The Radian measure of the  $135^\circ$  sector in each circle.
- 13a. What is the ratio of arc  $GH$  to arc  $RX$ ?
- b. What is the ratio of the areas of the two sectors?



## 7.9 Rays and Radians

### *A Solidify and Practice Understanding Task*

In the previous task, *Madison's Round Garden*, Madison found a new way to measure angles. Apparently Madison was not the first person to have this idea of measuring an angle in terms of arc length, but once she was aware of it she decided to examine it further.



©2013 www.flickr.com/photos/photo\_blackangel

Here are some of Madison's questions. See if you can answer them.

1. Since a  $40^\circ$  angle measures 0.698 radians (to the nearest thousandth), a  $50^\circ$  angle measures 0.873 radians, and a  $60^\circ$  angle measures 1.047 radians, what angle, measured in degrees, measures 1.000 radian?
2. A circle measures  $360^\circ$ . How many radians is that?
3. The formula Madison has been using to calculate radian measurement for an angle that measures  $n^\circ$  on a circle of radius  $r$  is  $\frac{n^\circ}{360^\circ} (2\pi r) = x \text{ radians}$ .

Is there a simpler formula for converting degree measurement to radian measurement?

4. What formula might you use to convert radian measurement back to degrees?

Madison is so excited about radian measurement she decides to learn more about it by going online. At <http://en.wikipedia.org/wiki/Radian> she finds this statement: *An arc of a circle with the same length as the radius of that circle corresponds to an angle of 1 radian. A full circle corresponds to an angle of  $2\pi$  radians.*

© 2013 Mathematics Vision Project | MVP

In partnership with the Utah State Office of Education

Licensed under the Creative Commons Attribution-NonCommercial-ShareAlike 3.0 Unported license.



5. Why is the first sentence in this statement true?
  
6. Why is the second sentence in this statement true?

Madison finds this idea of writing radian measurement in terms of  $\pi$  appealing. Since a circle measures  $2\pi$  radians, she reasons that half of a circle,  $180^\circ$ , would measure  $\pi$  radians; and that a quarter of a turn, a right angle, would measure  $\frac{\pi}{4}$  radians. Suddenly Madison realizes that while she has been deep in thought thinking about this new idea, she has been fiddling with her protractor. Now her attention focuses on this tool for measuring angles.

Like Madison, you have probably used a protractor to measure angles. A protractor is usually marked to measure angles in degrees. Madison decides she would like to create a protractor to measure angles in radians.

7. Label the following protractor in radians, using fractions involving  $\pi$ . You should label every  $10^\circ$  from  $0^\circ$  to  $180^\circ$ . For example, rays passing through the  $0^\circ$  and  $40^\circ$  angle mark would form an angle measuring  $\frac{2}{9}\pi$  (or  $\frac{2\pi}{9}$ ) radians, so we would label the tic mark at  $40^\circ$  as  $\frac{2\pi}{9}$ .

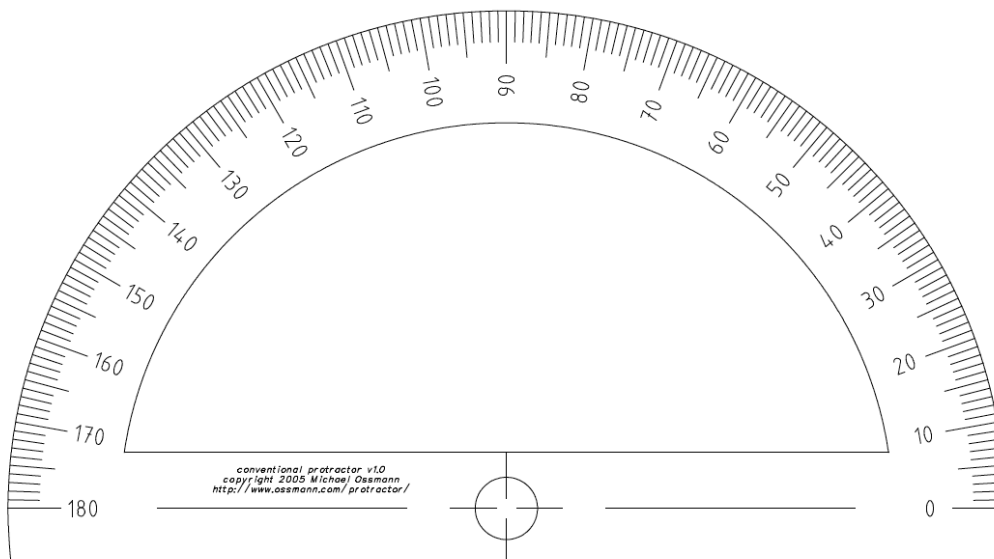

# 7.9 Rays and Radians – Teacher Notes

## *A Solidify and Practice Understanding Task*

---

**Note to teachers:** Be aware that you probably think about radians differently than your students will as they begin this task. Your definition of radians probably depends on an understanding of the unit circle, and perhaps a memorized set of radian measurements associated with standard angles such as  $30^\circ$  or  $120^\circ$ . Your students understand radians as a ratio of arc length to radius on any circle. In this task students observe that an angle that measures 1 radian on a circle has an arc length equal to the radius of the circle. They notice that a full revolution measures a bit more than 6 radians. For the first part of this task they will give decimal approximations for radian measure. Towards the end they will use fractions of  $\pi$  to measure angles in radians. Allow these ideas to evolve naturally without imposing your thinking on students. Students will use radian measurement in their study of circular trigonometric functions in Mathematics III.

**Purpose:** In this task students continue to examine and practice ideas and procedures associated with radians. Students observe that the circumference of a circle measures  $2\pi$  radians, and use this fact to name many standard angles as fractions of  $\pi$ . They also create and use a conversion factor,  $\pi/180^\circ$ , to convert degree measurements to radians.

### **Core Standards Focus:**

**G.C.5** Derive using similarity the fact that the length of the arc intercepted by an angle is proportional to the radius, and define the radian measure of the angle as the constant of proportionality; derive the formula for the area of a sector.

**Mathematics I Note for G.C.5:** *Emphasize the similarity of all circles. Note that by similarity of sectors with the same central angle, arc lengths are proportional to the radius. Use this as a basis for introducing radian as a unit of measure. It is not intended that it be applied to the development of circular trigonometry in this course.*

### **Related Standards:**

#### **Launch (Whole Class):**

The decimal approximations for the radian measurements of  $40^\circ$ ,  $50^\circ$  and  $60^\circ$  came from the previous task, so remind students that they have already calculated these values. Have students predict the degree measurement that they think is approximately equal to 1.000 radian, and then set them to work to calculate this value and to respond to the rest of the questions in the task.

#### **Explore (Small Group):**

Observe how students calculate the degree measurement for 1.000 radian. Do they guess and check using their formulas from the previous tasks, or do they use a conversion factor for converting



between radians and degrees? Do not press for this too soon, but by question 4 they should be recognizing that they can convert degrees to radians by multiplying by  $\frac{\pi}{180^\circ}$ , and from radians to degrees by multiplying by  $\frac{180^\circ}{\pi}$ .

The last half of the task looks at how many radians there are in a full revolution of  $360^\circ$ . You might have students experiment with laying out string the length of the radii around a circle, or alternatively, cutting a piece of string the length of the circumference and marking off unit lengths equal to the radius along this length of string. Students should notice that it takes a bit more than 6 radii to measure the distance around the circle. (If students are surprised that the radius does not divide the circumference evenly, remind them of the discussion about incommensurate units from task 3.9, *My Irrational and Imaginary Friends*. Remind students that the circumference and radius of a circle cannot both be rational numbers since their ratio is  $\pi$ , an irrational number.)

Encourage students to write appropriately reduced fractions for the radian measurements on the protractor.

### **Discuss (Whole Class):**

Begin the whole class discussion by asking students to explain why there are  $2\pi$  radians in a full circle. (Remind students that we are measuring the angle or amount of turn in a full revolution, not the distance around the circle.) Ask how many radians there are in a circle with three times the radius. Help students articulate that the radian measurement of a circle is  $2\pi$  regardless of the size of the circle, since we are finding the angle measurement, not the circumference.

Have students share their radian computations for different angle measurements on the protractor. Have students reduce their fractions if they have not already done so, but also look at some of the “counting patterns” around the protractor when fractions are not fully reduced, such as

every  $30^\circ$ :  $\frac{\pi}{6}, \frac{2\pi}{6}, \frac{3\pi}{6}, \frac{4\pi}{6}, \frac{5\pi}{6}, \frac{6\pi}{6}$ ; or every  $45^\circ$ :  $\frac{\pi}{4}, \frac{2\pi}{4}, \frac{3\pi}{4}, \frac{4\pi}{4}$ . Also examine some of the

equivalent names for  $90^\circ$ :  $\frac{3\pi}{6} = \frac{2\pi}{4} = \frac{\pi}{2}$  and  $180^\circ$ :  $\frac{6\pi}{6} = \frac{4\pi}{4} = \pi$ .

### **Aligned Ready, Set, Go: Circles: a Geometric Perspective 7.9**



Name:

## Circles: a Geometric Perspective | 7.9

## Ready, Set, Go!



©2013 www.flickr.com/photos/photo\_blackangel

## Ready

Topic: Angles, arcs and areas

Use the given information to find the desired values.

1. Given  $\odot B$  and marked angle measure.  
Find  $m\angle ADC$  and find the measure of  $\widehat{AC}$

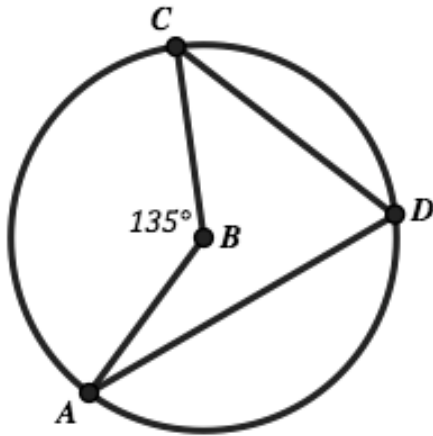

2. Given  $\odot D$  with marked radius.  
Find the measure of  $\widehat{FH}$  and find  $m\widehat{EF}$ .

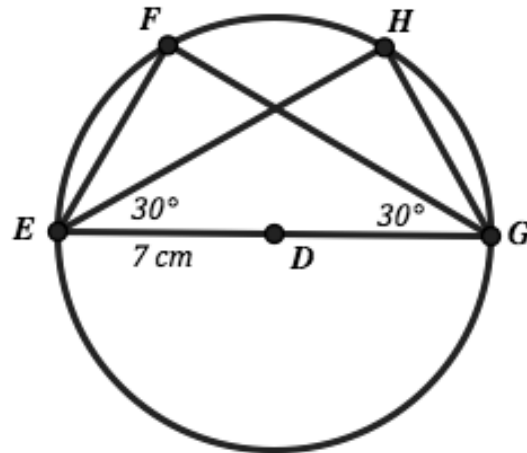

3. Given  $\odot K$  and marked angle measure.  
Find the measure of the length of  $\widehat{JL}$ .  
Find the radian measure that goes with the angle of  $125^\circ$

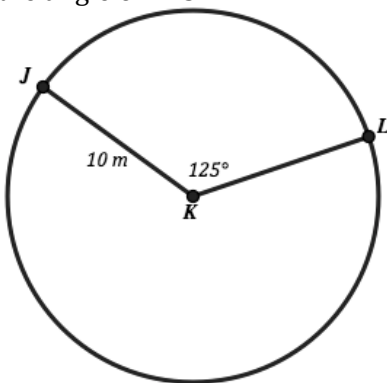

4. Given  $\odot K$  and marked angle measure.  
Find the area of the small sector.  
Find the arc length .

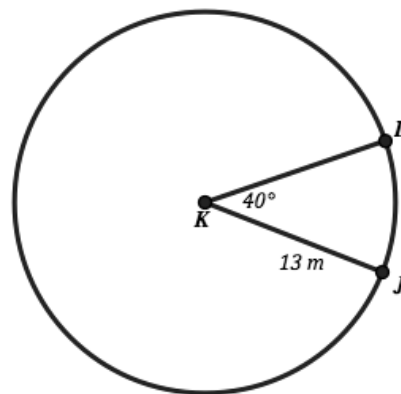



# Circles: a Geometric Perspective | 7.9

## Set

Topic: Converting between radians and degrees.

**Convert each angle measure to radians or degrees based on what is given.**

5.  $100^\circ =$       Radians      6.  $30^\circ =$       Radians      7.  $225^\circ =$       Radians

8.  $\frac{\pi}{3}$  Radians =      Degrees      9.  $5\pi$  Radians =      Degrees      10.  $\frac{5\pi}{4}$  Radians =      Degrees

11.  $270^\circ =$       Radians      12.  $90^\circ =$       Radians      13.  $150^\circ =$       Radians

## Go

Topic: Finding centers of rotation.

**Given the two figures below find the center of rotation that was used. Then use a compass to draw the concentric circles on which the vertex points of the triangle lie.**

14.

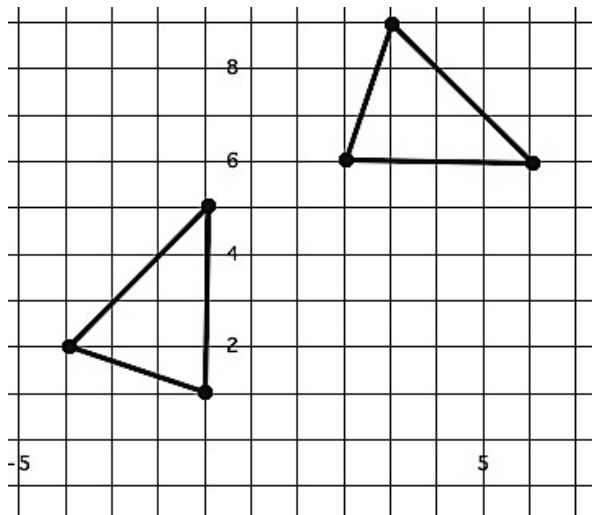

15.

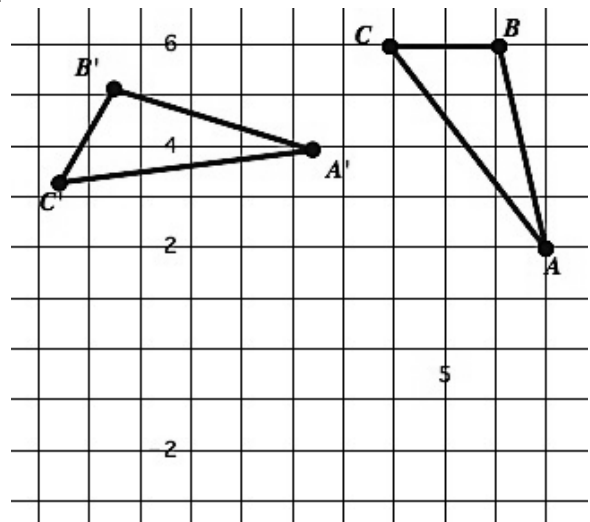

## 7.10 Sand Castles

### *A Solidify Understanding Task*

Benji, Chau and Cassandra plan to enter a sand castle building contest being sponsored by a local radio station. The winning team gets a private beach party at a local resort for all of their friends. To be selected for the competition, the team has to submit a drawing of their castle and verification that the design fits within the rules.



©2013 www.flickr.com/photos/kibm

The three friends actually plan to build three identical castles, each one twice as big as the previous one. They hope that replicating the same design three times—while paying attention to the tiniest little details—will impress the judges with their creativity and sand sculpting skill.

Benji is puzzling over a couple of questions on the application. They sound like math questions, and he wants Chau and Cassandra to make sure that he answers them correctly.

***Please provide the following information about your sand sculpture:***

- ***What is the total area of the footprint of your planned sand sculpture?***

*[This information will allow the planning committee to locate sand sculptures so the viewing public will have easy access to all sculptures. Remember that the total area occupied by your sculpture cannot exceed 50 sq. ft.]*

- ***What is the total volume of sand required to build your sand sculpture?***

*[We will provide clean, sifted sand for each team so we will not be liable for any debris or harmful substances that can be present in beach sand.]*

***I certify that the above information is correct.***

***Signature of team leader:*** \_\_\_\_\_ ***date:*** \_\_\_\_\_

The friends have only designed one of the castles, since the others will be scaled up versions of this one, each one being “twice as big”.

After studying the diagram Benji said, “I calculated the area of the footprint of the smallest castle to be 2.5 sq. ft., so the next one will occupy 5 sq. ft., and the largest 10 sq. ft. That’s a total of 17.5 sq. ft. Well within the limits.”

1. What do you think of Benji’s comment? Design a couple of possible “footprints” for a sand castle that will occupy 2.5 square units of area. Then scale each design up so it is “twice as big”, and calculate the area. What do you notice?



2. Imagine stacking cubes on your sand castle “footprints” to create a simple 3-D sculpture. Then scale up each design so it is “twice as big” and calculate the volume. What do you notice?
3. How did you interpret the phrase “twice as big” in your work on questions 1 and 2? Is your interpretation the same as Benji’s?
4. To avoid confusion, it would be more appropriate for Benji and his friends to say they are going to “scale up” their initial sand castle by a factor of 2. If the “footprint” of a sand castle occupies 2.5 sq. ft., is it possible to calculate the area occupied by a sand castle that has been enlarged by a scale factor of 2, or is the area of the enlarged shape dependent upon the shape of the original figure? That is, do triangles, parallelograms, pentagons, etc. all scale up in the same way? Write a convincing argument explaining why or why not?
5. What happens to the perimeter of the “footprint” of your sand castle when it is scaled-up by a factor of 2?
6. Suppose your sand castle “footprint” was cut out of a piece of Styrofoam that is one-inch thick. What happens to the volume when this “3-D footprint” is scaled up by a factor of 2?
7. What would happen to the perimeter of any face, the total surface area, and the volume of a triangular prism if it is scaled-up by a factor of 3? Build models or sketch diagrams to illustrate the reasoning behind your answer.

While Benji has been working on correcting the application, Chau and Cassandra have been looking online for information to help them calculate the volume of sand required, since their plans include prisms, pyramids, cylinders and cones.

Chau found this information: *The volume of a right prism or right circular cylinder is given by  $V = Bh$ , where  $B$  is the area of the surface that forms the base, and  $h$  is the height of the prism or cylinder. The volume of a pyramid or cone is  $1/3$  of the volume of a prism or cylinder with the same base and height.*

Kassandra found this information: *The volume of a prism or cone is given by  $V = Bh$ , where  $B$  is the area of the congruent cross sections parallel to the base, and  $h$  is the height of the prism. The volume of a pyramid or cone is  $1/3$  of the volume of a prism or cylinder with the same base and height.*

8. How do these two statements differ and what do those differences imply?



Chau and Cassandra are curious about the differences in these two definitions and so they continue searching online for more information. Chau is particularly concerned about why a pyramid or cone always has  $\frac{1}{3}$  of the volume of the related prism or cylinder with the same base and height. She remembers a teacher illustrating this idea by filling a few plastic pyramids with sand and pouring them into prisms with the same height and base. Each time it took three “pyramid’s full” of sand to exactly fill the corresponding prism. But now that she has taken geometry, Chau is more skeptical. She wonders, “Just because it works for those manufactured examples, does it work in every case?”

9. Do an online search for the following topics that Chau and Cassandra found interesting and relevant to their questions. Be prepared to report to your classmates what you learned. Keep track of particularly useful websites (e.g., easy to understand, great illustrations, dynamic images, hands-on activities, etc.) to share with your peers.
  - a. Cavalieri’s Principle
  - b. Disecting a prism into three pyramids of equal volume
  - c. Other (non-calculus) proofs of the relationship between the volumes of pyramids and prisms, cylinders and cones
  
10. Chau and Cassandra’s plans for the smallest sand castle includes columns in the shape of hexagonal prisms with the base being a hexagon that could be inscribed in a circle with a radius of 1 inch. The height of the column is 12 inches.
  - a. What is the volume of sand required to make each of these columns in the smallest sand castle?
  - b. What is the volume of sand required to make this column in the middle-sized sand castle?
  - c. What is the volume of sand required to make this column in the largest sand castle?
  - d. What is the circumference of the circle that will circumscribe the base of this column in the largest sand castle?
  
11. The plans for the smallest sand castle include a cone that is 5 inches high and has a circular base with a radius of 2 inches.
  - a. What is the volume of sand required to make this cone in the smallest sand castle?
  - b. What is the volume of sand required to make this cone in the middle-sized sand castle?
  - c. What is the volume of sand required to make this cone in the largest sand castle?
  - d. What is the circumference of the circle that forms the base of this cone in the largest sand castle?



# 7.10 Sand Castles – Teacher Notes

## *A Solidify Understanding Task*

---

**Purpose:** The purpose of this task is to deepen students understanding of the volume formulas for prisms, pyramids, cylinders and cones, particularly when applied to oblique (non-right) examples of these solids. Students have used these formulas in previous math courses as computational tools. In this task they examine informal, non-calculus arguments supporting these volume formulas in the same way they examined the formulas for circumference and area of a circle based on informal limit arguments (see task 7.4 and 7.5). In this task students also examine the proportionality relationships of lengths, areas, and volumes when geometric figures are scaled up.

### **Core Standards Focus:**

**G.GMD.1** Give an informal argument for the formulas for the circumference of a circle, area of a circle, volume of a cylinder, pyramid, and cone. Use dissection arguments, Cavalieri’s principle, and informal limit arguments.

**G.GMD.3** Use volume formulas for cylinders, pyramids, cones, and spheres to solve problems.★

**Note for Mathematics II:** *Informal arguments for area and volume formulas can make use of the way in which area and volume scale under similarity transformations: when one figure in the plane results from another by applying a similarity transformation with scale factor  $k$ , its area is  $k^2$  times the area of the first. Similarly, volumes of solid figures scale by  $k^3$  under a similarity transformation with scale factor  $k$ .*

### **Related Standards:**

#### **Launch (Whole Class):**

Introduce the context of this task by reading the first few paragraphs, including the application for the sand castle building competition. Remind students that they have previously used formulas for finding perimeters and areas of regular polygons and circles, and (in other math courses) formulas for finding volumes of prisms, pyramids, cylinders and cones. Point out questions 10 and 11 where they will be asked to use these formulas to solve some problems relative to the sand castle context. Point out the “scaling up” idea that is present in these questions and then return to the paragraphs following the application and read through Benji’s comment and question 1 of the task. Then set students to work on 1-8. If they finish early, they are to read through question 9, which will be assigned as homework, and then work on questions 10 and 11.

#### **Explore (Small Group):**

Watch for students who interpret “twice as big” in the same way Benji did (double the area), as well as students who interpret it as doubling the linear dimensions of the figure. Allow both perspectives to coexist until question 4, when all students should be working from the “scale factor”



perspective of doubling all of the linear dimensions. Students should have at least two different “footprints” of their own design to experiment with as they consider these questions. Watch for unusual designs (e.g., non-rectangular). You may want to prompt some groups to try something unusual, like a triangle with an area of 2.5 sq. in., or an L-shaped figure, or something else. Listen for arguments that indicate whether or not students understand that the design of the base doesn’t matter in calculating the area of the scaled up figure, since linear dimensions will all get doubled as the figure gets scaled up.

Have fast finishers read through the rest of the task and work on problems 10 and 11.

**Discuss (Whole Class):**

The whole class discussion should focus on the way area and volume scale under similarity transformations: when one figure in the plane results from another by applying a similarity transformation with scale factor  $k$ , its area is  $k^2$  times the area of the first. Similarly, volumes of solid figures scale by  $k^3$  under a similarity transformation with scale factor  $k$ . Emphasize the idea of “scaling up” as a similarity transformation. Use student work on questions 5-7 to highlight this concept.

As a class, read through the two statements that precede question 8, and then discuss question 8. One big idea that should come out of this discussion is that as long as the corresponding “slices” or cross sections parallel to the base of a prism, pyramid, cylinder or cone have the same area, the resulting solid has the same volume. A simplistic illustration of this would be a deck of cards skewed so it is no longer a right prism, or a stack of pennies skewed so it is no longer a right cylinder (perhaps stacked so it isn’t “cylindrical” at all). These are simple examples of Cavalieri’s principle, but the principle says more: the corresponding “slices” don’t need to be congruent shapes, we just need to verify that each slice has the same area. Students may encounter examples of this during their online research.

By now, students should recognize Chau’s concern about the formula for the volume of a pyramid based on a few examples as a legitimate one. This may not be fully resolved by looking at some online arguments, but at least students will have acknowledged that this issue is at the heart of mathematical proof.

Assign problem 9, doing some online research about these topics, as homework. There are some great visual resources online. Here are a few you might suggest:

<http://www.korthalsaltes.com/model.php?name=en=three%20pyramids%20that%20form%20a%20cube>

[This site provides a template for nets that can be folded into pyramids so that three such pyramids form a cube. The nets are provided in two sizes, so the issue of scaling up area and volume is also accessible with these nets]



<http://math.stackexchange.com/questions/623/why-is-the-volume-of-a-cone-one-third-of-the-volume-of-a-cylinder>

[This site includes a dynamic animation of the three pyramids that form a cube. It also illustrates how a cone can have the same volume as a pyramid—thus illustrating Cavalieri’s principle for non-congruent cross sections]

[http://ceemrr.com/Geometry2/Pyramid\\_Cone/Pyramid\\_Cone\\_print.html](http://ceemrr.com/Geometry2/Pyramid_Cone/Pyramid_Cone_print.html)

[This site includes a dynamic animation of Cavalieri’s principle. It also illustrates how to decompose a triangular prism into three pyramids, and then generalizes the visual “proof” of the pyramid formula to general pyramids by showing that all prisms can be decomposed into triangular prisms.]

If there is time remaining, have students work on problems 10 and 11. Assign these questions as homework if students don’t finish them in class.

**Aligned Ready, Set, Go: Circles: a Geometric Perspective 7.10**



Name:

## Circles: a Geometric Perspective | 7.10

**Ready, Set, Go!**

©2013 www.flickr.com/photos/klbm

**Ready**

Topic: Finding the center of a circle.

**Previously you have worked with finding the center or rotation between pre-image and image points. Using a very similar strategy find the center of the circles below.**

(Use chords of the circle to pinpoint the center.)

1.

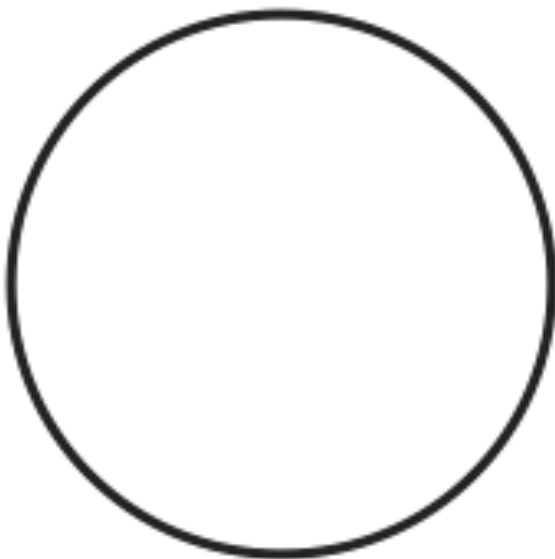

2.

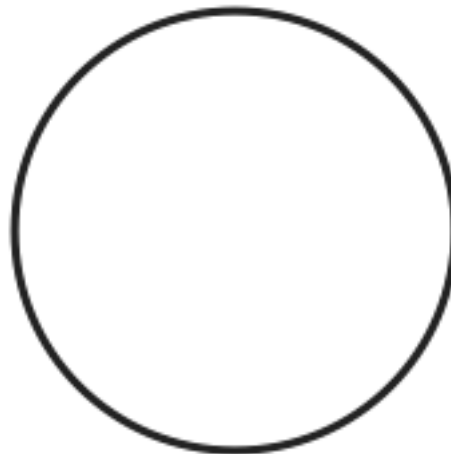

3. Justify your work for finding the center of the circles above. Why does it work? Why does it pinpoint the center of the circle?

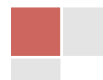



**Set**

Topic: Finding surface area and volume.

**Find the volume and surface area of each pyramid.**

4.

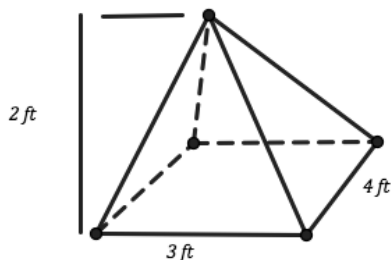

5. A pyramid that is similar to the pyramid in number 4 but scaled up by a factor of 3.

6.

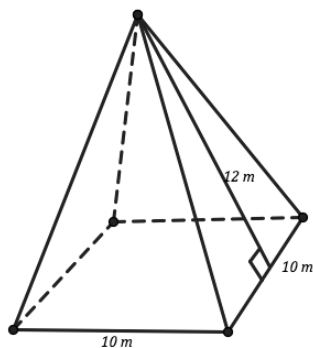

7. A pyramid that is similar to the pyramid in number 6 but scaled up by a factor of 5.

**Find the volume and surface area of each rectangular prisms.**

8.

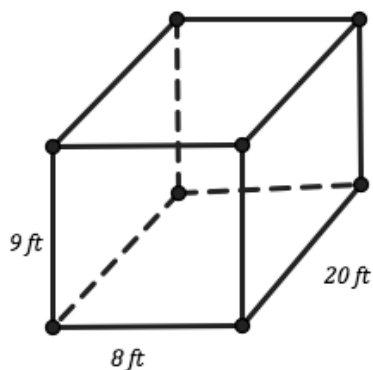

9. A prism similar to the one on the left that has been enlarged by a factor of 4.

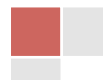

## Circles: a Geometric Perspective | 7.10

Find the volume for each cylinder and cone.

10.

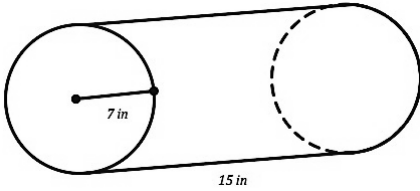

11. A cylinder that is similar to the one at the left that has been scaled up by a factor of 2.

12.

Radius = 5 ft

Height = 15 ft

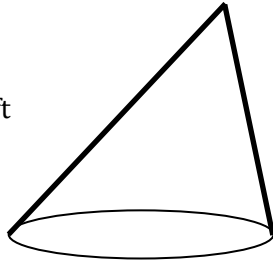

13. A cone that is similar to the one at the left that has been scaled up by a factor of 4.

### Go

Topic: Radians and degree conversions, sectors of circles

Find the measure that is missing, either degrees or radians given the other measure.

14.  $120^\circ =$  Radians      15.  $270^\circ =$  Radians      16.  $210^\circ =$  Radians

17.  $\frac{3\pi}{4}$  Radians = Degrees      18. 4.7 Radians = Degrees      19.  $\frac{\pi}{6}$  Radians = Degrees

20.  $300^\circ =$  Radians      21.  $180^\circ =$  Radians      22.  $360^\circ =$  Radians

Find the area of each sector.

23.

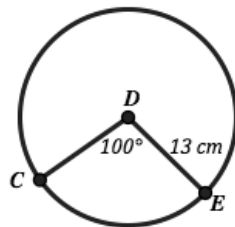

24.

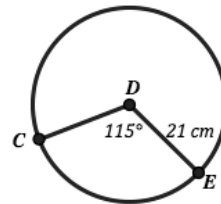

Find the measure of the length of each arc indicated below.

25.

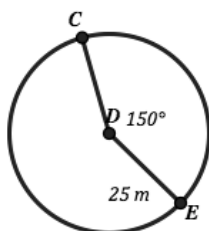

26.

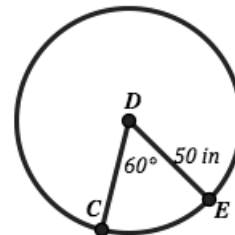

## 7.11H Cavalieri to the Rescue

### *A Solidify Understanding Task*



©2013 www.flickr.com/photos/expertinfantry

Carlos, Clarita, and Zac are playing a geometry game. Each player selects a point  $C$  on the line segment  $\overline{MN}$ , which is parallel to line segment  $\overline{AB}$ . The points  $A$ ,  $B$  and  $C$  form the vertices of a triangle. The player who creates the triangle with the largest area wins the game.

Carlos has placed his point at position  $C_1$ , Clarita has selected point  $C_2$ , and Zac has chosen to locate his point at  $C_3$ . Now they are discussing their choices before calculating the areas of each triangle to determine the winner.

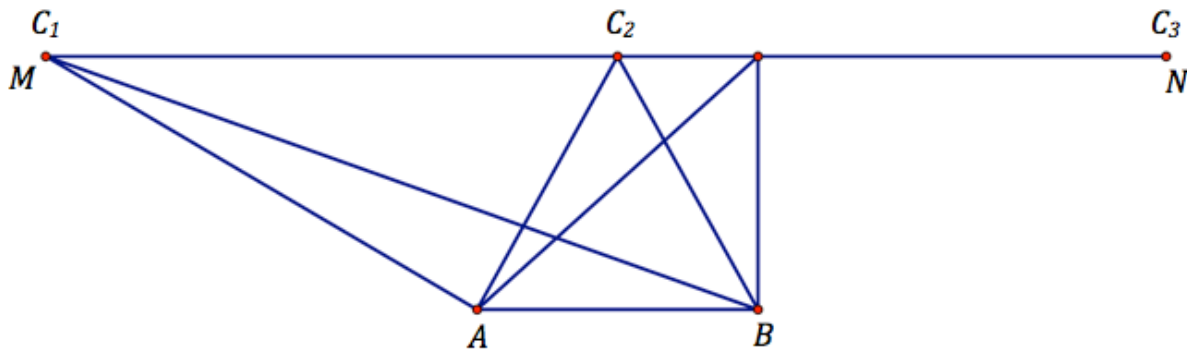

Carlos: I chose my point so the triangle would stretch as far left as possible, enclosing a large amount of area.

Clarita: I thought it would be best to create an isosceles triangle so the triangle would be symmetric about its altitude, so I chose a point on segment  $MN$  directly above the midpoint of segment  $AB$ .

Zac: I thought that a right triangle would create the largest triangle, since my triangle would be half of a rectangle.

1. Without doing any calculations, who do you think created the triangle with the largest area?
2. If you were playing the game with Carlos, Clarita and Zac, where would you place your point  $C$ ? Mark a point on segment  $MN$  to represent your best guess. You may mark your point at the same position as one that has already been chosen, if you agree that point would form the largest triangle.

© 2013 Mathematics Vision Project | MVP

In partnership with the Utah State Office of Education

Licensed under the Creative Commons Attribution-NonCommercial-ShareAlike 3.0 Unported license.



- Now it is time to determine a winner. Make any measurements necessary to calculate the winner of the game. Whose strategy won?

Carlos, Clarita and Zac were initially surprised by the results and wondered why the triangle images were so deceptive. They began to wonder if they could really believe their calculations. Then Carlos suggested an experiment. He drew a series of line segments in each triangle, with each segment parallel to the base of the triangle,  $\overline{AB}$ , and with corresponding segments in each of the triangles drawn at the same distance above the base, as shown in the diagram below. Carlos then measured each of the corresponding line segments.

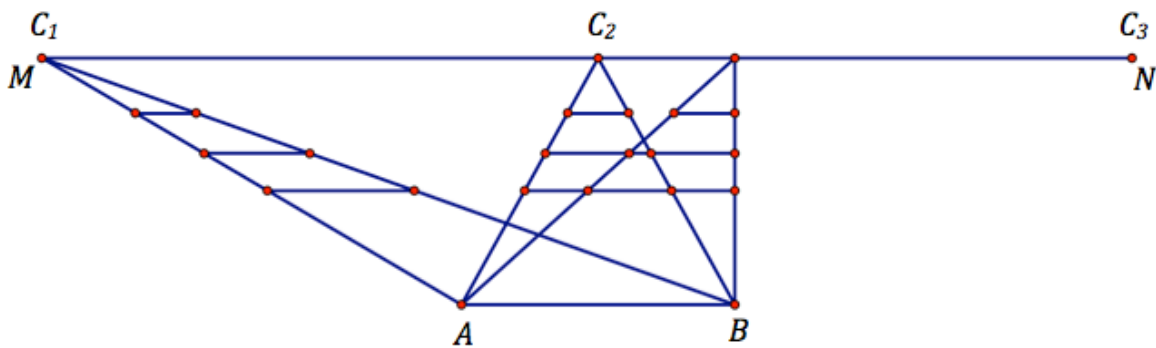

- Complete Carlos' experiment by measuring each of the corresponding line segments. What do you notice? What does this observation suggest about the areas of the triangles, and why?

Clarita said, "It feels like you are treating each triangle as if it was made up of a bunch of layers or slices."

Zac, inspired by Clarita's comment, pulled a handful of pennies out of his pocket and stacked them to form a cylinder. "I can calculate the volume of this stack of coins using the formula  $V = Bh$ . But what if I tilt the stack so it looks more like the Leaning Tower of Pisa. Now how do I figure out how much space the coins occupy?"

Carlos and Clarita smiled at Zac's clever way of illustrating an idea that was new to both of them. They were excited to tell their geometry teacher about their discovery and Zac's principle. They were surprised to hear that Zac wasn't the first person to think of it, and that it was known as Cavalieri's principle.

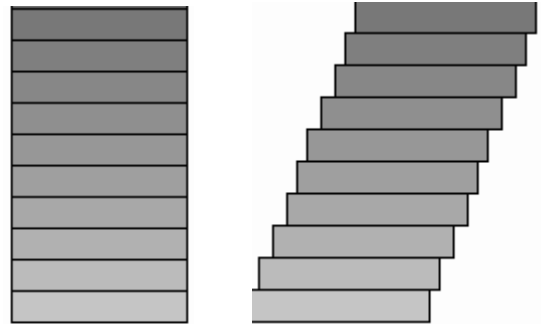

5. In your own words, state what you think Cavalieri's principle is, based on the triangle experiment and the stack of coins illustration.

Try out another experiment with Cavalieri's principle. Once again, line  $MN$  is parallel to segment  $AB$ . Measure the length of segment  $AB$ , and then mark a congruent segment  $CD$  anywhere on line  $MN$ . Connect the endpoints of segment  $AB$  to the endpoints of segment  $CD$  to form a parallelogram. Mark another segment  $EF$  on line  $MN$  so that  $EF$  is also congruent to  $AB$ . Connect the endpoints of segment  $AB$  to the endpoints of segment  $EF$  to form another parallelogram.

6. Use these two non-congruent parallelograms to illustrate Cavalieri's principle. What can you say about the areas of these two parallelograms, and what convinces you this is true?

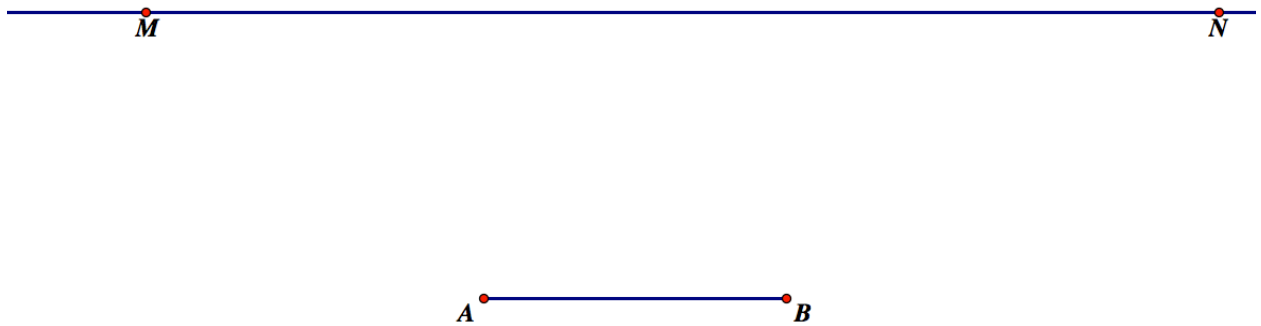

# Cavalieri to the Rescue – Teacher Notes

## *A Solidify Understanding Task*

---

**Purpose:** The purpose of this task is to introduce Cavalieri’s principle. Typically, students have been introduced to the formula for finding the area of a triangle by cutting a rectangle or parallelogram in half along a diagonal to form two congruent triangles whose areas are given by  $A = \frac{bh}{2}$ . In a similar manner, the area formula for a parallelogram is often derived by “cutting off” a triangle from one side of the parallelogram and moving it to the other side to form a rectangle of equal area. In this task students explore the more general idea that all triangles with the same base and height will have the same area, regardless of their shape. This is not intuitively obvious, even though the area formula suggests it should be true. Students explore why this is true by envisioning triangles as made up of layers or slices, and considering what it would mean if each corresponding slice of two different triangles contributed the same amount of area to the total area of their respective triangles. A similar experiment allows students to conclude that two non-congruent parallelograms with the same base and height contain the same area.

Students also examine a 3-dimensional example of a right circular cylinder and an oblique cylinder with the same height and same cross sections, and conclude that the two cylinders will occupy the same volume. In Secondary Math III students will revisit Cavalieri’s principle to justify the volume formulas of solid figures, particularly the volume of spheres and cones.

### **Core Standards Focus:**

**G.GMD.2** Give an informal argument using Cavalieri’s principle for the formulas for the volume of a sphere and other solid figures.

### **Related Standards:**

#### **Launch (Whole Class):**

While students know the formula for finding the area of a triangle, it will probably not occur to them that this implies that all three triangles in Carlos, Clarita and Zac’s game have the same area. Allow students to initially believe that the areas are different, based on their intuition about the shape of the triangles. If someone suggests that the areas are the same, ask if they are sure, since we typically think of the area formula for a triangle as being derived from cutting a rectangle or parallelogram in half along a diagonal. Carlos’ triangle doesn’t seem to be half of a parallelogram or rectangle, so it should give students reason to wonder about whether or not the formula applies in this case. Make sure everyone makes a prediction for the largest triangle, before continuing on with the remainder of the task.



**Explore (Small Group):**

Remind students that the altitude of a triangle may fall outside of the region occupied by the triangle. Help students recognize that the height of all three triangles is the same, and therefore, according to the area formula, all three triangles should contain the same area. This may still seem implausible to students until they start working on Carlos' experiment.

Make sure students are measuring corresponding segments in each of the three triangle as they work on Carlos' diagram. Suggest that they start with the top segments in each triangle, since they do not overlap. As they measure other segments, make sure students are measuring segments from side to side of each triangle. Students should observe that corresponding segments are all the same length.

It may be unclear to students what Clarita is saying about "layers" or "slices". Ask students what would happen if we were to continue to draw corresponding line segments in each triangle? Since our pencil lead has a bit of thickness, eventually we could fill in the area of a triangle by just drawing parallel (thick) line segments. Each slice contributes a small amount to the total area of the triangle. Since each triangle can be composed of the same set of (thick) line segments—just stacked differently—all three triangles would contain the same amount of area.

**Discuss (Whole Class):**

Focus the discussion on stating a clear definition of Cavalieri's principle, which is,

- **2-dimensional case:** Suppose two regions in a plane are included between two parallel lines in that plane. If every line parallel to these two lines intersects both regions in line segments of equal length, then the two regions have equal areas.
- **3-dimensional case:** Suppose two solids are included between two parallel planes. If every plane parallel to these two planes intersects both regions in cross-sections of equal area, then the two regions have equal volumes.  
(see [http://en.wikipedia.org/wiki/Cavalieri's\\_principle](http://en.wikipedia.org/wiki/Cavalieri's_principle))

**Aligned Ready, Set, Go: Circles: a Geometric Perspective 7.11H**

### Ready, Set, Go!

#### Ready

Topic: Using the distance formula.

Find the distance between the given points.

Recall that that  $d = \sqrt{(x_2 - x_1)^2 + (y_2 - y_1)^2}$

- 1. A (5, -7) and B (-3, 8)      2. H (2, 3) and G (6, 0)      3. K (-2,-13) and L (-7, -1)
- 4. M (-4, 2) and N (2, -6)      5. P ( 0, 9) and Q (9, 0)      6. S (-7, 11) and T (13, 11)



©2013 www.flickr.com/photos/expertinfantry

#### Set

Topic: Applying Cavalieri's Theorem.

7. Below are 3 quadrilaterals. Compare the perimeters and the areas. How are they the same and how are they different?

Did any of your calculations surprise you?

Explain.

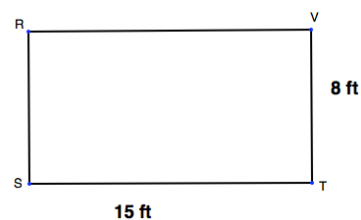
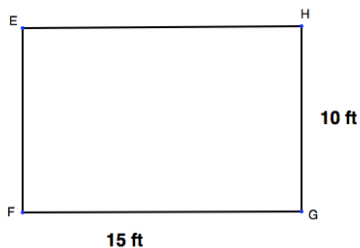
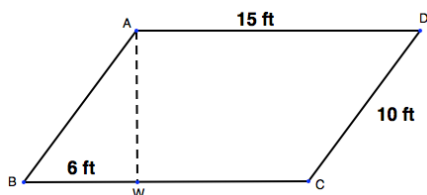

8. The figure below contains several triangles:  $\triangle HAF$ ,  $\triangle HDF$ ,  $\triangle HDG$ ,  $\triangle AFD$ , and  $\triangle AGD$ . Given that  $\overline{AD} \parallel \overline{HG}$ , which triangles have the same area? Justify your answer.

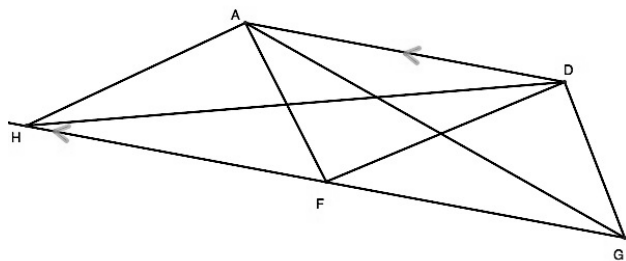



9. The figure at the right shows a cube with edges of length  $(a + b)$  that has been sliced into pieces by three planes parallel to its faces.

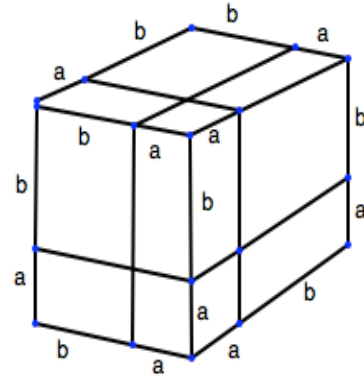

- Write an expression for the volume of the cube in terms of  $a$  and  $b$ .
- Into how many pieces is the cube cut?
- 
- How many of these pieces are also cubes?
- Write an expression in terms of  $a$  and  $b$  for the volume of each cube you found.
- How many pieces have a volume of  $a^2b$ ?
- How many pieces have a volume of  $ab^2$ ?
- Write the volume of the figure as the sum of the volumes of its pieces.
- Can you make your expression in "g" match the expression in "a"?

**Go**

Topic: Congruent and similar solids

**Determine if each pair of solids is similar, congruent, or neither. Justify your answers.**

10.

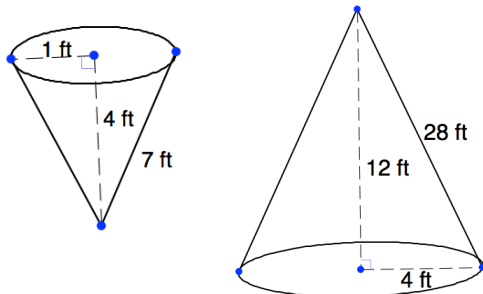

Similar, congruent, or neither?

How do you know?



11.

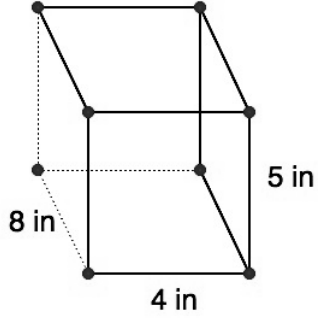
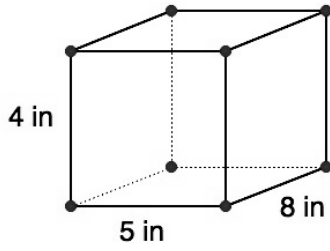

Similar, congruent, or neither?

How do you know?

12.

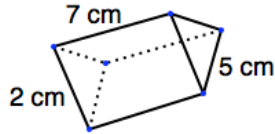
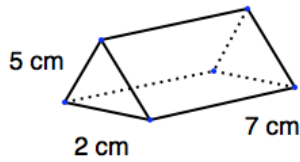

Similar, congruent, or neither?

How do you know?

